



X3-ULTRA

15 kW / 19.9 kW / 20 kW / 25 kW / 30 kW

User Manual

Version 6.0

www.solaxpower.com



eManual in the QR code or at <http://kb.solaxpower.com/>

STATEMENT

Copyright

Copyright © SolaX Power Network Technology (Zhejiang) Co., Ltd. All rights reserved.

No part of this manual may be reproduced, transmitted, transcribed, stored in a retrieval system, or translated into any language or computer language, in any form or by any means without the prior written permission of SolaX Power Network Technology (Zhejiang) Co., Ltd.

Trademarks



SOLA X and other symbol or design (brand name, logo) that distinguishes the products or services offered by SolaX has been trademark protected. Any unauthorized use of the above stated trademark may infringe the trademark right.

Notice

Please note that certain products, features, and services mentioned in this document may not be within the scope of your purchase or usage. Unless otherwise specified in the contract, the contents, information, and recommendations presented in this document are provided "as is" by SolaX. We do not provide any warranties, guarantees, or representations, whether express or implied.

The content of the documents is reviewed and updated as needed. However, occasional discrepancies may occur. SolaX retains the right to make improvements or changes in the product(s) and the program(s) described in this manual at any time without prior notice.

The images included in this document are solely for illustrative purposes and may differ based on the specific product models.

For more detailed information, kindly visit the website of SolaX Power Network Technology (Zhejiang) Co., Ltd. at www.solaxpower.com.

SolaX retains all rights for the final explanation.

About This Manual

Scope of Validity

This manual is an integral part of X3-ULTRA series inverter. It describes the installation, electrical connection, commissioning, maintenance and troubleshooting of the product. Please read it carefully before operating.

This manual is valid for the following inverter models:

- X3-ULT-15K
- X3-ULT-15KP
- X3-ULT-19.9K (Applicable to Italy)
- X3-ULT-20K
- X3-ULT-20KP
- X3-ULT-25K
- X3-ULT-30K

Model Description

X3-ULT-15K

1

2

Item	Meaning	Description
1	Product family name	"X3-ULTRA" refers to the energy storage inverter that supports grid connection of photovoltaic system.
2	Power	"15K" refers to the rated output power of 15 kW.



Target Group

The installation, maintenance and grid-related setting can only be performed by qualified personnel who:

- Are licensed and/or satisfy state and local jurisdiction regulations.
- Have good knowledge of this manual and other related documents.

Conventions

The symbols that may be found in this manual are defined as follows.

Symbol	Description
 DANGER	Indicates a hazardous situation which, if not avoided, will result in death or serious injury.
 WARNING	Indicates a hazardous situation which, if not avoided, could result in death or serious injury.
 CAUTION!	Indicates a hazardous situation which, if not avoided, could result in minor or moderate injury.
NOTICE!	Provides tips for the optimal operation of the product.

Change History

Version 06 (2024-04-28)

Modified company address.

Added a note below the "Max. input current" section in the technical parameters: "Maximum output current for a single MPPT string: 18A when both strings are connected; 20A when only one string is connected."

Corrected the pin connections for Datahub/heat pump on the inverter side.

Changed the address for the heat pump to 96 on page 149.

Removed the color of the inverter body.

Added relevant content regarding arc pulling.

Version 05 (2024-04-02)

Added (xxxx for VDE 4105);

Version 04 (2024-03-28)

Removed heat shrink tubing from the PE terminals;

Modified PV terminals, added dust caps to the accessory package;

Added section 8.1.2 Cable Connections of Inverter;

Inserted corresponding text for accessory package numbers;

Updated contact information for Turkey and Italy; removed personal contact information and emails for South Africa and Pakistan;

Optimized diagrams for setting power factor and Pu function sections;

Optimized connection diagrams in the document, added connection points at joints;

Changed "Max. inverter backfeed current to the array [A]" to 0;
Modified "X3-Parallel EPS BOX" to "X3-EPS Parallel BOX".

Version 03 (2024-01-30)

Added model 20KP;
Removed "Coming soon" for BMS-Parallel Box-II G2 on P52;
Removed UKCA;
Updated contact information;
Changed the torque for communication port connectors to 0.4;
Changed the electricity meter to CT in the diagram on P151.

Version 02 (2023-12-28)

Changed the plug of the BAT end (updated the diagram);
Added supplementary explanation for Idle status on P12;
Added electric shock prevention warning on P45 (required connection of Grid and EPS terminals before device power-on);
Adjusted cover logo, added illustrations;
Changed PV and PE cables;
Corrected pin connection for system switch;
Added step 4 EPS debugging on section 8.2;
Added notice (used special tools for disassembly);
Changed AC terminals;
Changed the cap of the dongle;
Adjusted the order of some chapters;
Updated the QR code;
Added TOU mode;
Added model 15KP;
Changed parallel cabinet to X3-Parallel EPS BOX;
Added lockable DC switch on;
Updated accessory package, updated tools requirement.

Version 01 (2023-11-07)

Corrected the error code of "INterComFault" to "IE25";
Changed WiFi-p to WiFi+LAN;
Modified the cover product image;

Added a comparison of power output between regular EPS mode and Super-Backup mode.

Version 00 (2023-10-11)

Initial release

Table of Contents

1	Safety	1
1.1	General Safety	1
1.2	Safety Instructions of PV, Inverter and Grid	1
1.2.1	Safety Instructions of PV	2
1.2.2	Safety Instructions of Inverter	2
1.2.3	Safety Instructions of Utility Grid	3
2	Product Overview	4
2.1	System Description	4
2.2	Appearance	4
2.3	Supported Power Grid	5
2.4	Symbols on the Label and Inverter	6
2.5	Working Principle	7
2.5.1	Circuit Diagram	7
2.5.2	Application Schemes	8
2.6	Working State	10
2.7	Working Mode	11
2.7.1	Self-use Mode (Priority: Loads > Battery > Grid)	11
2.7.2	Feed-in Priority (Priority: Loads > Grid > Battery)	13
2.7.3	Backup Mode (Priority: Loads > Battery > Grid)	14
2.7.4	Peak Shaving Mode	16
2.7.5	TOU Mode	17
2.7.6	EPS Mode (Priority: Loads > Battery)	18
2.7.7	Manual Mode	19
2.7.8	Export Control Function	19
3	System Overview	21
4	Transportation and Storage	24
5	Preparation before Installation	25
5.1	Selection of Installation Location	25
5.1.1	Environment Requirement	25
5.1.2	Installation Carrier Requirement	26
5.1.3	Clearance Requirement	27
5.2	Tools Requirement	28
5.3	Additionally Required Materials	29

- 6 Unpacking and Inspection 30**
 - 6.1 Unpacking.....30
 - 6.2 Scope of Delivery.....31
- 7 Mechanical Installation 33**
 - 7.1 Dimensions for mounting.....34
 - 7.2 Installation procedures.....35
- 8 Electrical Connection 38**
 - 8.1 Overview of Electrical Connection38
 - 8.1.1 Terminals of Inverter.....38
 - 8.1.2 Cable Connections of Inverter.....39
 - 8.2 PE Connection42
 - 8.3 AC Connection.....44
 - 8.4 PV Connection48
 - 8.5 Battery Power Cable Connection.....52
 - 8.6 COM 1 Communication Connection58
 - 8.6.1 Pin Assignment of COM 1 Terminal.....58
 - 8.6.2 Parallel Communication Connection.....59
 - 8.6.3 BMS Communication Connection62
 - 8.6.4 RS485 Communication Connection64
 - 8.6.5 DRM Connection (Applicable to AS/NZS 4777)65
 - 8.7 COM 2 Communication Connection.....67
 - 8.7.1 Pin Assignment of COM 2 Terminal.....67
 - 8.7.2 Meter/CT Connection.....68
 - 8.7.3 Ripple Control Communication Connection75
 - 8.7.4 DIO Communication Connection.....76
 - 8.8 Monitoring Connection79
- 9 System Commissioning 82**
 - 9.1 Checking before Power-on82
 - 9.2 Powering on the System.....82
 - 9.3 Operation of lockable DC Switch83
- 10 Operation on LCD..... 85**
 - 10.1 Introduction of Control Panel.....85
 - 10.2 Introduction of Menu Interface86
 - 10.3 System ON/OFF.....89
 - 10.4 Mode Select89
 - 10.5 System Status91
 - 10.6 History Data.....93

10.7	Setting	95
10.7.1	User Setting.....	95
10.7.2	Advanced Setting	102
10.8	About.....	118
11	Operation on SolaX Cloud App.....	119
11.1	Introduction of SolaX Cloud App.....	119
11.2	Downloading and installing App.....	119
11.2.1	Downloading and installing App.....	119
11.3	Operation Guide on SolaXCloud Web	120
12	Troubleshooting and Maintenance	121
12.1	Power off.....	121
12.2	Troubleshooting.....	121
12.3	Meter/CT Fault	130
12.4	Maintenance.....	131
12.4.1	Maintenance routines	131
12.4.2	Replacement of Fans.....	132
12.4.3	Upgrading Firmware.....	133
13	Decommissioning.....	136
13.1	Disassembling the Inverter	136
13.2	Packing the Inverter	140
13.3	Disposing of the Inverter	140
14	Technical Data	141
15	Appendix	146
15.1	Application of Generator.....	146
15.1.1	Introduction of generator application	146
15.1.2	Notice for generator application	146
15.1.3	ATS control mode	146
15.1.4	Dry contact mode.....	148
15.2	Application of Adapter Box G2	151
15.2.1	Introduction of Adapter Box G2 application	151
15.2.2	Communication connection with inverter.....	151
15.3	Application of EV-Charger.....	154
15.3.1	Introduction of EV-Charger application.....	154
15.3.2	Wiring connection diagram	154
15.3.3	Charging modes.....	154
15.3.4	Communication connection with inverter.....	155
15.3.5	Setting for EV-Charger.....	156

15.4 Application of DataHub	157
15.4.1 Introduction of DataHub application	157
15.4.2 Wiring connection diagram	157
15.4.3 Communication connection with inverter.....	158
15.4.4 Settings for DataHub.....	158
15.5 Micro-grid Application	160
15.5.1 Introduction of Micro-grid application	160
15.5.2 Wiring conenction diagram	160
15.5.3 Working modes.....	161
15.5.4 Cable connection (Hybrid inverter)	163
15.5.5 Cable connection (On-grid inverter).....	163
15.5.6 Cable connection (Meter).....	163
15.6 Application of Parallel Function	165
15.6.1 Introduction of parallel application.....	165
15.6.2 Notice for parallel application	165
15.6.3 System wiring procedure	167

1 Safety

1.1 General Safety

The series inverter has been meticulously designed and thoroughly tested to comply with the relevant state and international safety standards. Nevertheless, like all electrical and electronic equipment, safety precautions must be observed and followed during the installation of the inverter to minimize the risk of personal injury and ensure a safe installation.

Please thoroughly read, comprehend, and strictly adhere to the comprehensive instructions provided in the user manual and any other relevant regulations prior to the installation of the inverter. The safety instructions in this document serve as supplementary guidelines to local laws and regulations.

SolaX shall not be liable for any consequences resulting from the violation of the storage, transportation, installation, and operation regulations outlined in this document. Such consequences include, but are not limited to:

- Inverter damage caused by force majeure events, such as earthquakes, floods, thunderstorms, lightning, fire hazards, volcanic eruptions, and similar events.
- Inverter damage due to human causes.
- Usage or operation of the inverter in violation of local policies or regulations.
- Failure to comply with the operation instructions and safety precautions provided with the product and in this document.
- Improper installation or usage of the inverter in unsuitable environmental or electrical conditions.
- Unauthorized modifications to the product or software.
- Inverter damage occurring during transportation by the customer.
- Storage conditions that do not meet the requirements specified in this document.
- Installation and commissioning performed by unauthorized personnel who lack the necessary licenses or do not comply with state and local jurisdiction regulations.

1.2 Safety Instructions of PV, Inverter and Grid

Save these important safety instructions. Failure to do so may result in damage to the inverter and injury or even loss of life.

1.2.1 Safety Instructions of PV



Potential risk of lethal electrical shock associated with the photovoltaic (PV) system

- Exposure to sunlight can result in the generation of high DC voltage by PV modules, which can lead to electric shock causing severe injuries or even death.
- Never touch the positive or negative poles of the PV connecting device, and avoid touching both poles simultaneously.
- Do not ground the positive or negative poles of the PV modules.
- Only qualified personnel can perform the wiring of the PV modules.



- Overvoltage protection with surge arresters should be provided when the PV power system is installed. The inverter is fitted with SPDs on both PV input side and MAINS side.
- Please consult professionals before installing SPDs.



- Make sure that the input DC voltage does not exceed the maximum DC input voltage specified for the inverter. Overvoltage can cause irreversible damage to the inverter, and such damage is not covered by the warranty.

1.2.2 Safety Instructions of Inverter



Potential risk of lethal electrical shock associated with the inverter

- Only operate the inverter if it is in a technically faultless condition. Operating a faulty inverter may lead to electric shock or fire.
- Do not attempt to open the enclosure without authorization from SolaX. Unauthorized opening of the enclosure will void the warranty and can result in lethal danger or serious injury due to electric shock.
- Make sure that the inverter is reliably grounded before any operation to prevent the risk of electric shock causing lethal danger or serious injury.
- Only qualified personnel can perform the installation, wiring, maintenance of the inverter by following this document and the related regulations.



- Prior to any wiring connection, establishing an earth connection is essential.

 **WARNING!**

- During operation, avoid touching any parts of the inverter other than the DC switch and LCD panel.
- Never connect or disconnect the AC and DC connector while the inverter is running.
- Prior to conducting any maintenance, turn off the AC and DC power and disconnect them from the inverter. Wait for 5 minutes to fully discharge the energy.

 **WARNING!****Potential danger of scalding due to the hot enclosure of the inverter**

- Avoid touching the inverter while it is running, as it becomes hot during operation and may cause personal injuries.

 **WARNING!**

- When handling the battery, carefully follow all safety instructions provided in the battery manual. The battery used with the inverter must meet the specified requirements of the series inverter.

 **CAUTION!**

- Make sure that children are supervised to prevent them from playing with the device.
- Pay attention to the weight of the inverter and handle it properly to avoid personal injuries.
- Use insulated tools when installing the device, and always wear personal protective equipment during installation and maintenance.

NOTICE!

- If an external Residual Current Device (RCD) is required by local regulations, verify the type of RCD required. It is recommended to use a Type-A RCD with a rating of 300 mA unless a lower value is required by the specific local electric codes. When required by local regulations, the use of an RCD type B is permitted.
- Keep all product labels and the nameplate on the inverter clearly visible and well-maintained.

1.2.3 Safety Instructions of Utility Grid

NOTICE!

- Only connect the inverter to the grid with the permission of the local utility grid company.

2 Product Overview

2.1 System Description

The X3-ULTRA series is the energy storage inverter that supports grid connection of photovoltaic system. It greatly meets the requirements of solar-powered roofs and supports various intelligent solutions such as load management, wireless metering, dual battery terminals, microgrids, etc., to achieve efficient and economical energy utilization. The X3-ULTRA series can be used with different capacities of SolaX battery.

2.2 Appearance

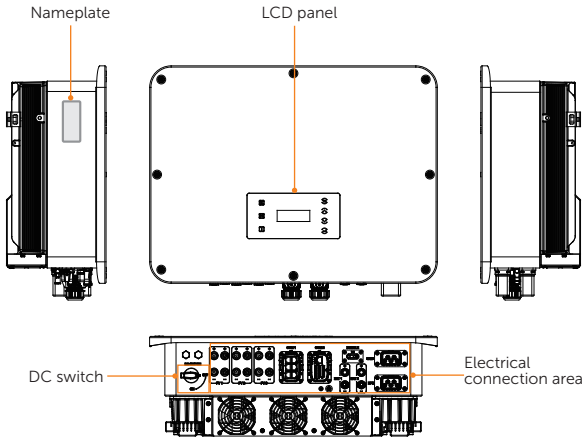

Figure 2-1 Appearance

Table 2-1 Description of appearance

Item	Description
Nameplate	Nameplate clearly identifies the device type, serial number, specific DC/AC parameters, certification, etc.
LCD panel	Including screen, indicators and keys. Screen displays the information; indicators indicate the status of inverter. Keys are used to perform the parameter setting.
DC switch	Disconnect the DC circuit when necessary.
Electrical connection area	Including PV terminals, battery terminals, AC terminals, communication terminals, etc.

2.3 Supported Power Grid

There are different ways of wiring for different grid systems. TT / TN-S / TN-C-S are shown as below:

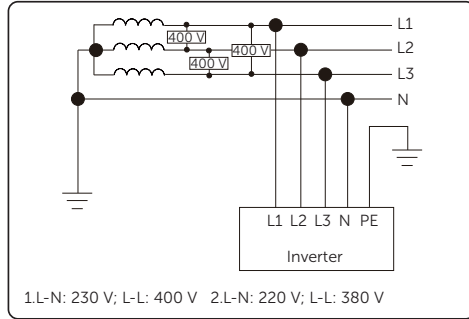

Figure 2-2 Supported power grid-TT

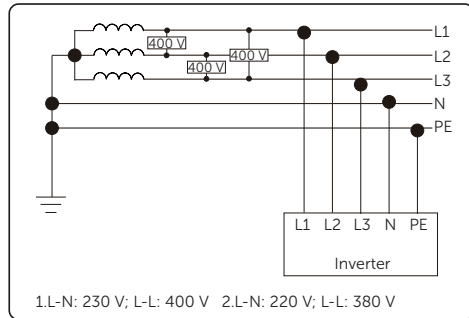

Figure 2-3 Supported power grid-TN-S

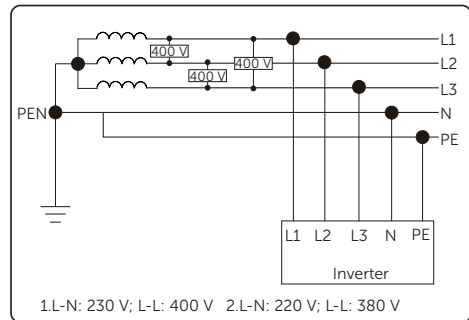













Figure 2-4 Supported power grid-TN-C-S

2.4 Symbols on the Label and Inverter

Table 2-2 Description of symbols

Symbol	Description
	CE mark. The inverter complies with the requirements of the applicable CE guidelines.
	TUV certified.
	RCM mark. The inverter complies with the requirements of the applicable RCM guidelines.
	Additional grounding point
	Beware of hot surface. Do not touch a running inverter, as the inverter becomes hot during operation!
	Risk of electric shock. High voltage exists after the inverter is powered on!
	Risk of danger. Potential hazards exist after the inverter is powered on!
	Observe enclosed documentation.
	The inverter can not be disposed together with the household waste.
	Do not operate this inverter until it is isolated from battery, mains and on-site PV generation source.
	Danger to life due to high voltage. Residual voltage exists after the inverter is powered off, which needs 5 minutes to fully discharge. Wait 5 min before attempting any service.

2.5 Working Principle

2.5.1 Circuit Diagram

The inverter is equipped with multi-channel MPPT for DC input to ensure maximum power even under different photovoltaic input conditions. The inverter unit converts DC into AC that meets the requirements of the power grid and feeds it into the power grid. The principle design of inverter is shown in the figure below:

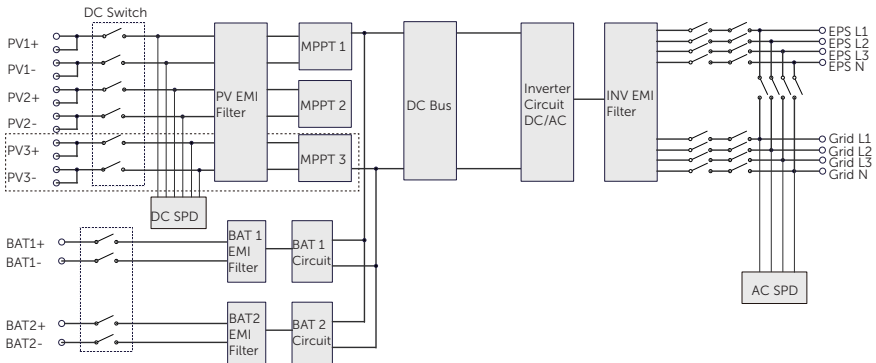

Figure 2-5 Circuit Diagram for X3-ULTRA series inverter

NOTICE!

- MPPT 3 is available for X3-ULT-15KP, 20KP, 25K and 30K inverter.

2.5.2 Application Schemes

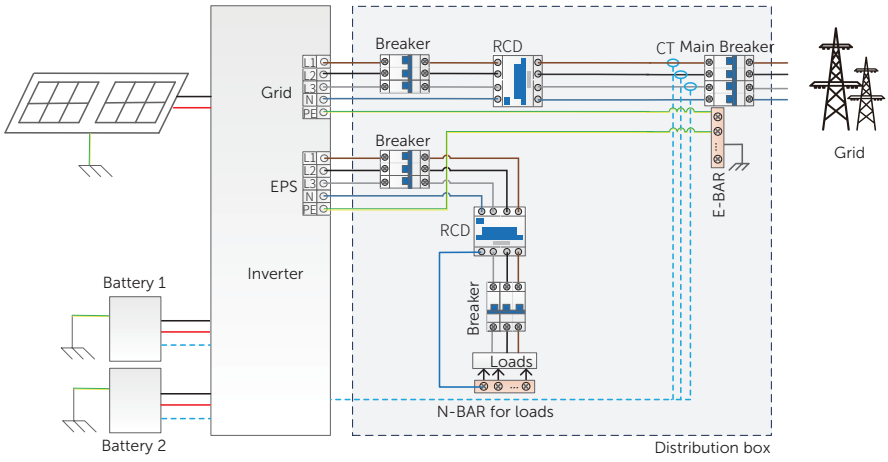

Figure 2-6 Whole home backup for most countries

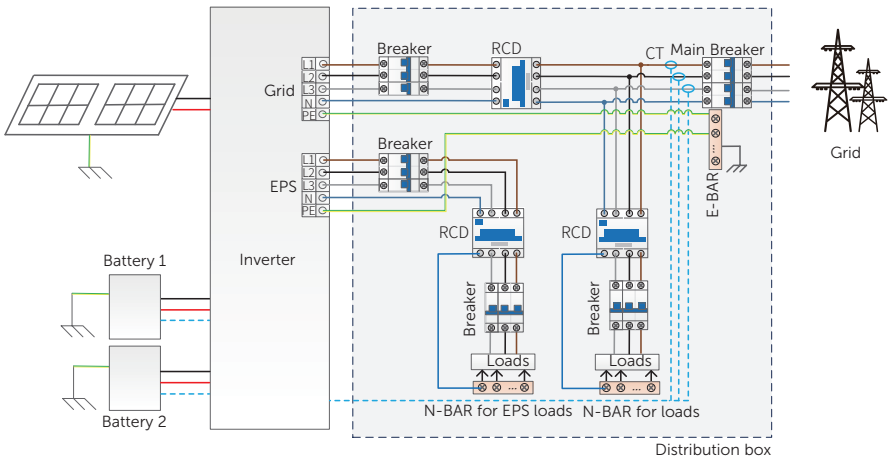

Figure 2-7 Partial home backup for most countries

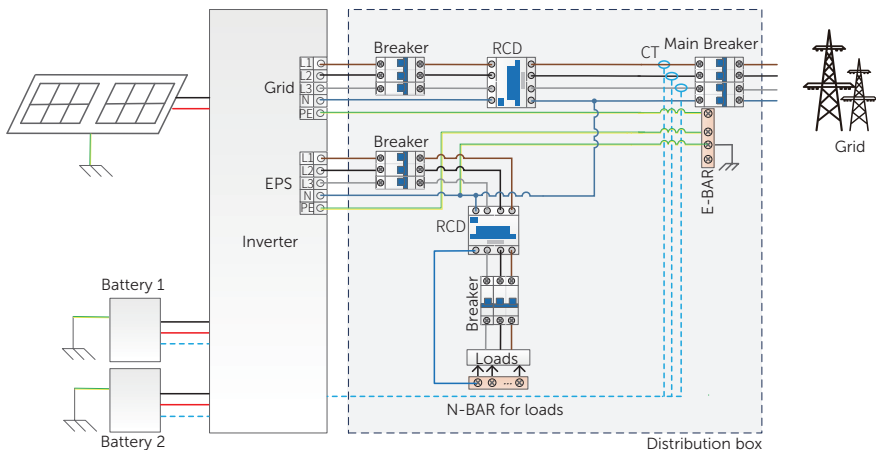

Figure 2-8 Whole home backup for Australia

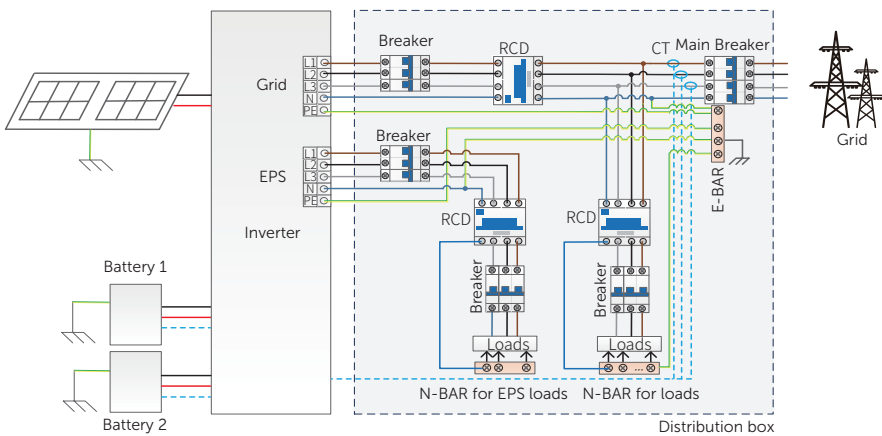

Figure 2-9 Partial home backup for Australia

2.6 Working State

The series inverter has Waiting, Checking, Normal, EPS Checking, EPS, Fault, Idle and Standby state.

Table 2-3 Description of working state

State	Description
Waiting	<p>The inverter is waiting for the following two conditions to be met in order to enter the Checking state:</p> <ul style="list-style-type: none"> • The adequate photovoltaic input voltage. • The AC side voltage and frequency meet the grid requirements specified by the grid regulations.
Checking	<ul style="list-style-type: none"> • The inverter is checking for conditions to enter Normal state.
Normal	<ul style="list-style-type: none"> • The inverter is working normally.
EPS Checking	<ul style="list-style-type: none"> • The inverter is checking for conditions to enter EPS state.
EPS	<ul style="list-style-type: none"> • The inverter is working in off-grid state.
Fault	<ul style="list-style-type: none"> • The inverter detects error occurred and prompts error code.
Idle	<ul style="list-style-type: none"> • The battery SOC reaches the minimum SOC and there is no sufficient PV input voltage, etc.
Unusual Idle	<ul style="list-style-type: none"> • The battery needs to be charged but PV and grid power are not allowed to charge the battery
Standby	<ul style="list-style-type: none"> • A standby state when the power of load is extremely low and there is no sufficient PV input voltage, or a state when the battery SOC is more 10% and there is no sufficient PV input voltage. • In this state, it detects PV connection, load power, etc to determine whether to exit Standby state and enter Normal state.

NOTICE!

- When the inverter is in an Idle state, you can reset the work mode, the Min SOC and the charging periods through the inverter LCD or the SolaX APP to charge the battery to the Min SOC in the charging periods and then awaken the inverter. Please make sure that the actual battery SOC - the modified Min SOC \geq 2% under a specific work mode, so that other modifications are effective. When the current system time is within the new charging periods you reset, the battery begins charging.

2.7 Working Mode

Six working modes are available for you to choose in on-grid status, i.e Self use, Feed-in priority, Backup, Peak shaving, TOU and Manual. You can choose the working modes according to your lifestyle and environment.

When the power supply from the electric power company is stopped due to a power outage, it automatically switches to EPS mode and connects to the distribution board for a specific load, thereby providing power to important electrical appliances.

For how to set the working mode, please refer to the section "10.7.1 User Setting".

2.7.1 Self-use Mode (Priority: Loads > Battery > Grid)

The self-use mode is suitable for areas with low feed-in subsidies and high electricity prices. The power of PV will supply the loads first, and the surplus power will charge the battery, then the remaining power will feed into the grid.

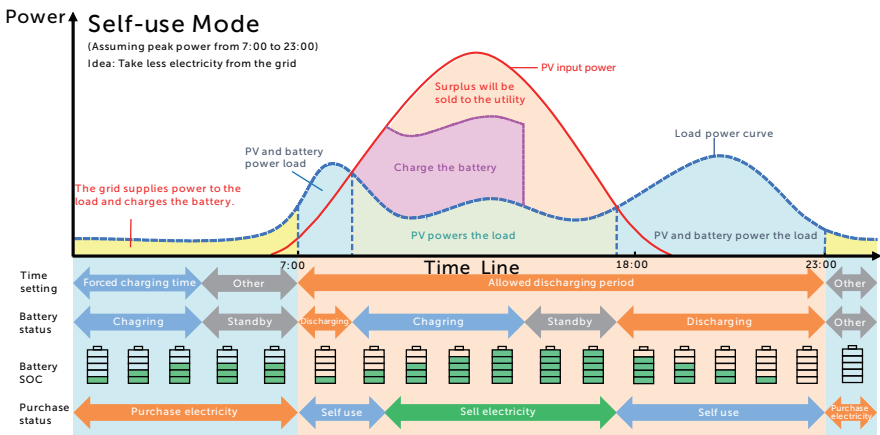

Figure 2-10 Self-use mode

NOTICE!

- Set the export control according to the safety code.

Table 2-4 Description of self-use mode

Time period	Inverter working status
Forced charging period	<ul style="list-style-type: none"> • Charge the battery firstly until the battery SOC reaches the specified Charge battery to value. You can configure the inverter to either draw power from the grid or not.

Allowed discharging period

PV is sufficient
(PV → load → battery → grid)

- The power generated from PV prioritizes supplying the load. Any excess power is then directed towards charging the battery, and if there is still surplus electricity, it can be sold to the grid. In the event that the local utility restricts the sale of electricity to the grid, the **Export Control** can be set to limit the output to the grid. For specific settings, please refer to "[Setting Export Control](#)".

PV is insufficient
(PV+battery → load)

- The battery discharges power to the load, and once its capacity reaches **Min SOC**, it automatically ceases discharging.

Note:

Charge battery to: The battery SOC charged from grid. 30% by default, the settable range is 10%~100%.

Min SOC: Minimum SOC of the battery under grid connection. 10% by default, the settable range is 10%~100%.

Charge & Discharge Period

You can set two configurable working periods: forced charging period and allowed discharging period. The interval not in the charging & discharging period belongs to other time periods.

- Forced charging period (Default period: 00:00~00:00, closed by default)

In the forced charging period, the inverter will charge the battery first until the battery SOC reaches the specified **Charge battery to** value set in each working mode. You have the option to configure the inverter to either draw power from the grid or not.

- Allowed discharging period (Default period: 00:00~23:59)

In the allowed discharging period, the inverter will allow the battery to discharge and charge power in accordance with the working mode and load conditions.

- Period not set as forced charging or allowed discharging period

In this period, the inverter will allow the battery to charge but can not discharge power.

NOTICE!

- The charging and discharging period is only applicable for self-use mode, feed-in priority and backup mode. The priority of forced charging period is higher than all working modes.

2.7.2 Feed-in Priority (Priority: Loads > Grid > Battery)

The feed-in priority mode is suitable for areas with high feed-in subsidies. The power generated from PV is directed towards supplying the loads. Any excess power beyond the load requirements will be fed into the grid.

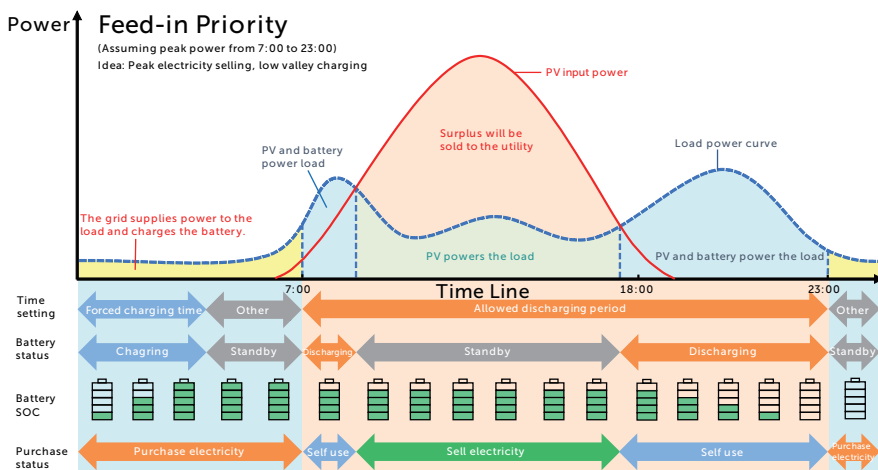

Figure 2-11 Feed-in priority

Time period	Inverter working status
Forced charging period	<ul style="list-style-type: none"> Charge the battery firstly until the battery SOC reaches the specified Charge battery to value. You can configure the inverter to either draw power from the grid or not.
Allowed discharging period	<p>PV is sufficient (PV → load → grid → battery)</p> <ul style="list-style-type: none"> The power generated from PV is directed towards supplying the loads. Any excess power beyond the load requirements will be fed into the grid. <p>PV is insufficient (PV+battery → load)</p> <ul style="list-style-type: none"> PV and battery supply power to the load at the same time, and once the battery capacity reaches Min SOC, it automatically ceases discharging.

Note:

Charge battery to: The battery SOC charged from grid. 50% by default, the setttable range is 10%~100%.

Min SOC: Minimum SOC of the battery under grid connection. 10% by default, the setttable range is 10%~100%.

NOTICE!

- You can set two configurable working periods: forced charging period and allowed discharging period in feed-in priority mode. Please refer to "Charge & Discharge Period" for details. In this mode, consider whether the battery can be charged during the day. If it cannot be charged, it is recommended to set a forced charging time period during off-peak electricity rates and allow charging from the grid to the battery.

2.7.3 Backup Mode (Priority: Loads > Battery > Grid)

The backup mode is suitable for areas with frequent power outages.

This mode will maintain the battery capacity at relatively high level to ensure that the emergency loads can be used when grid is off. Same working logic with self-use mode.

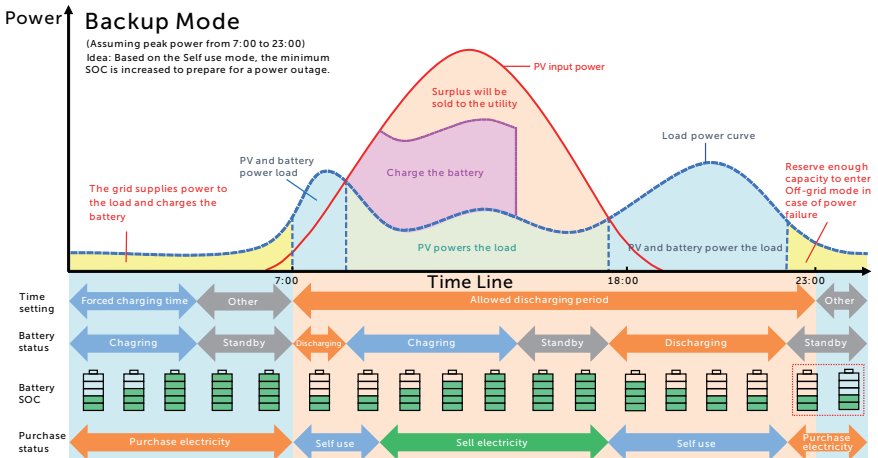

Figure 2-12 Backup mode

Table 2-5 Description of backup mode

Time period	Inverter working status
Forced charging period	<ul style="list-style-type: none"> Charge the battery firstly until the battery SOC reaches the specified Charge battery to value. You can configure the inverter to either draw power from the grid or not.

Allowed discharging period

The working logic remains the same as for self-use mode. The difference is:

- In the self-use mode when there is no PV input and the battery SOC reaches **Min SOC¹** (on-grid min SOC), the battery will enter a dormant state. At this time, if the grid power is lost, the inverter cannot switch to EPS mode.
- In the backup mode, when there is no PV input and the battery reaches **Min SOC** (on-grid min SOC), the inverter enters standby. At this time, if the grid power is lost, it will switch to EPS mode until the battery is discharged to the **Min SOC²** (off-grid min SOC).

Note:

Min SOC¹ (on-grid min SOC): Minimum SOC under grid connection. 30% by default, the settable range is 30%~100%.

Min SOC² (off-grid min SOC): Minimum SOC under off-grid conditions. 10% by default, the settable range is 10%~100%.

NOTICE!

- You can set two configurable working periods: forced charging period and allowed discharging period in backup mode. Please refer to "[Charge & Discharge Period](#)" for details.

NOTICE!

- If there is a foreseeable power outage, it is advisable to switch to backup mode in advance from other modes.

2.7.4 Peak Shaving Mode

Peak shaving mode is set for leveling out peaks in electricity use. The system is intelligently controlled to ensure charging takes place during off-peak hours and discharging occurs during peak hours.

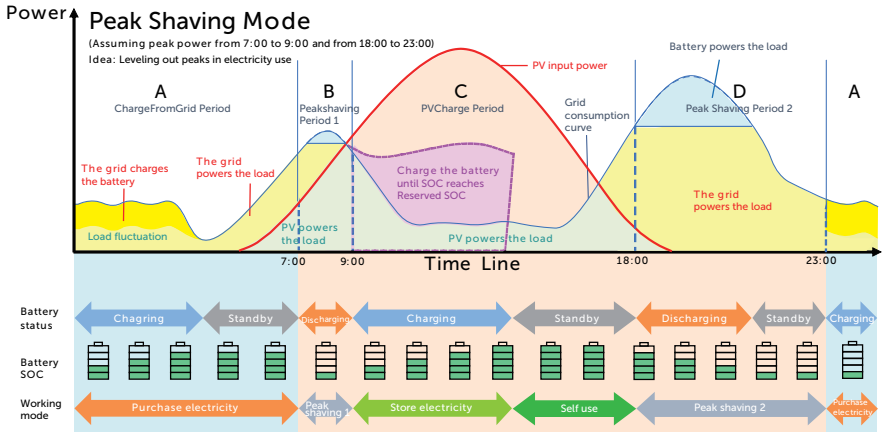

Figure 2-13 Peakshaving mode

Table 2-6 Description of peakshaving mode

Time Period	Inverter working status
Period A	<ul style="list-style-type: none"> The grid can charge the battery to MaxSOC within the set ChargePowerLimits. In this period, the battery will not discharge power.
Period B & D	<p>Grid consumption power < PeakLimits (PV + grid → load)</p> <ul style="list-style-type: none"> The PV and grid will power the load. The battery will not charge or discharge power.
Period C	<p>Grid consumption power > PeakLimits (PV + battery + grid → load)</p> <ul style="list-style-type: none"> The battery will discharge energy for loads and thus reduce the amount of energy purchased from the grid. <p>(PV → battery → load → grid)</p> <ul style="list-style-type: none"> The battery does not discharge power. The PV charges the battery up to the Reserved SOC before supplying power to the loads. Any excess power beyond the load requirements is first supplied to the loads, and then fed into the grid.

Note:

MaxSOC: The energy taken from grid to charge the battery. 50% by default, the settable range is 10%-100%.

ChargePowerLimits: The charging power from grid. 1000 W by default, the settable range is 0-60000 W

PeakLimits: The load consumption from grid side. 0 W by default, the settable range: 0-60000 W.

Reserved SOC: The lower limit of battery SOC required for later peak shaving period. 50% by default, the settable range is 10~100%.

2.7.5 TOU Mode

In the TOU mode, different working modes, i.e Self-use, Charging, Discharging, Peaking shaving and Battery off can be set for different time periods in accordance with actual needs and environment conditions through SolaX Cloud App or Web.

The day can be divided into up to 24 time slots, and the minimum time slot is 15 minutes, independent working mode can be set for each time slot. Please refer to Web Guide or App Guide for details about how to set the TOU mode.

Time Slot	Working Mode
X:XX~X:XX (e.g 0:00~0:15)	Choose one mode from Self-use / Charging / Discharging / Battery off / Peaking shaving

Note:

Self-use: Same working logic with "Self-use Mode", but it is not limited by the charging and discharging time slots. The priority of PV: Loads > Battery > Grid.

Charging: The power of PV will charge the battery as much as possible to the set SOC of Charge BAT to (%). You can set whether to Charge from grid. The default value of Charge BAT to (%) is 100%. When the battery reaches the set SOC, the surplus power will perform "Self-use Mode" or supply to the grid (based on the system setup), at this point, Charge from grid is not allowed.

Discharging: If allowed by the battery, the system outputs a specified power from the grid based on the set output percentage, controlling the power at the AC port. You need to set the RatePower (%) through Web or App when choosing Discharging mode. When the battery Discharge to (%) reaches the set SOC, the inverter performs "Self-use Mode".

Peak shaving: The working logic is that when the power consumption from the grid exceeds the set PeakLimit value, the battery is allowed to discharge power. The excess power beyond the limit is provided by the combination of photovoltaic and battery to ensure that the maximum power purchased from the grid does not exceed the set limit. You need to set the PeakLimit value through Web or App when choosing Peak shaving mode.

Battery off: The battery neither charges nor discharges. The power of PV will supply to loads or the grid. Only when the battery SOC is lower than the system (TOU) Min SOC, the battery can be charged.

2.7.6 EPS Mode (Priority: Loads > Battery)

During a power failure, the system will provide uninterrupted power supply to the EPS loads using the power from PV and the battery. It is important to ensure that the EPS loads should not exceed the maximum output power of the battery.

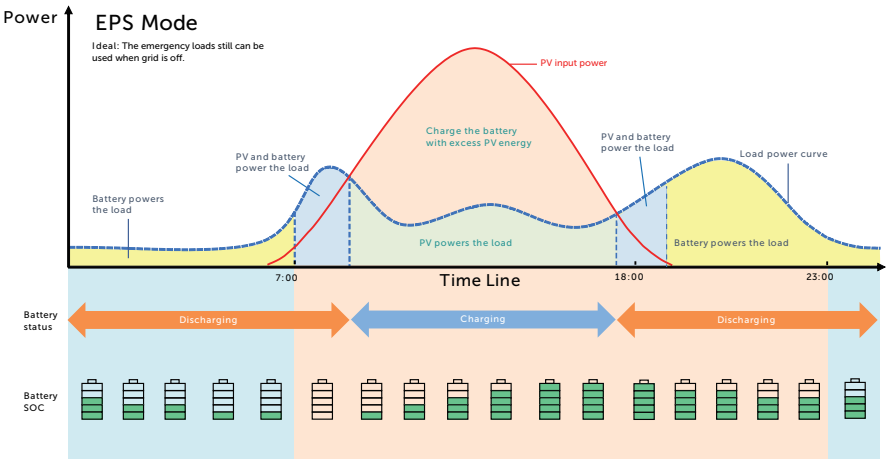

Figure 2-14 EPS mode

Table 2-7 Description of EPS mode

Battery SOC	Inverter working status
Battery SOC > Min SOC (in off-grid mode)	<p>PV is sufficient (PV → load → battery)</p> <ul style="list-style-type: none"> The PV prioritizes supplying power to the load, with any excess energy being directed towards charging the battery.
Battery SOC ≤ Min SOC (in off-grid mode)	<p>PV is insufficient (PV + battery → load)</p> <ul style="list-style-type: none"> The PV prioritizes supplying power to the load. If the energy is not enough, the battery will discharge power until the battery SOC reaches Min SOC and then error of BatPowerLow will be reported. <p>The inverter reports BatPowerLow. When there is PV, it will charge the battery first. After charging to the set Min ESC SOC value, it will be automatically recovered and enter EPS mode again.</p>

Note:

Min SOC: Minimum SOC of the battery under off-grid conditions. 10% by default, the settable range: 10%-100%.

Min ESC SOC: The minimum SOC of the battery to enter EPS mode. 30% by default, the settable range: 15%-100%.

NOTICE!

- When the battery supplies power to the load, the available capacity of the battery decreases as the SOC decreases.

2.7.7 Manual Mode

This working mode is only for the professional technical personnel to perform debugging and maintenance. It includes **Forced Discharge**, **Forced Charge** and **Stop chrg&dischrg**. The system will restore to the original working mode after six hours Manual mode set.

2.7.8 Export Control Function

Solar export control is a limit on the amount of energy your solar system that can export into the grid. You have a set limit on how much energy you can export to the grid.

How Export Control works

- CT/meter required
- Correct setting of the limit value of **Export Control** through inverter. (For parallel system, set on the master inverter)

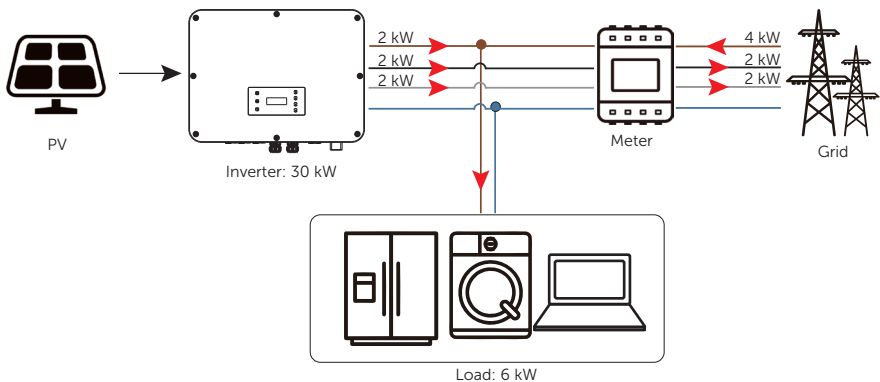

Figure 2-15 Zero export control with **Phase Unbalance** disabled

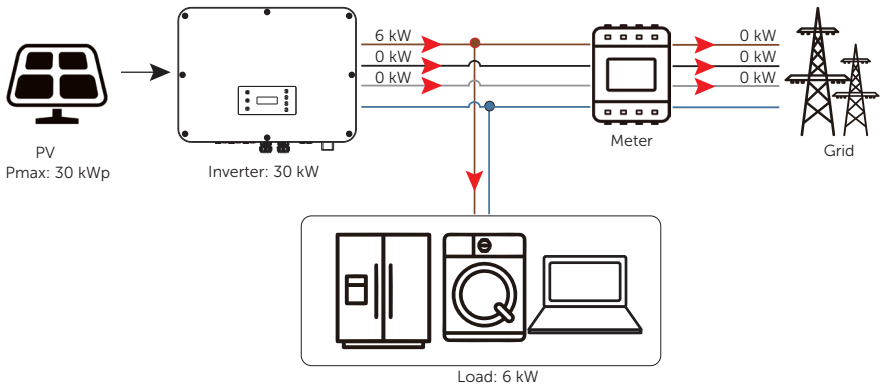

Figure 2-16 Zero export control with **Phase Unbalance** enabled

Note:

Export Control value can be set from 0W to more than the rated output power.

For how to set the **Export Control** function, please refer to "[Setting Export Control](#)".

3 System Overview

System Overview

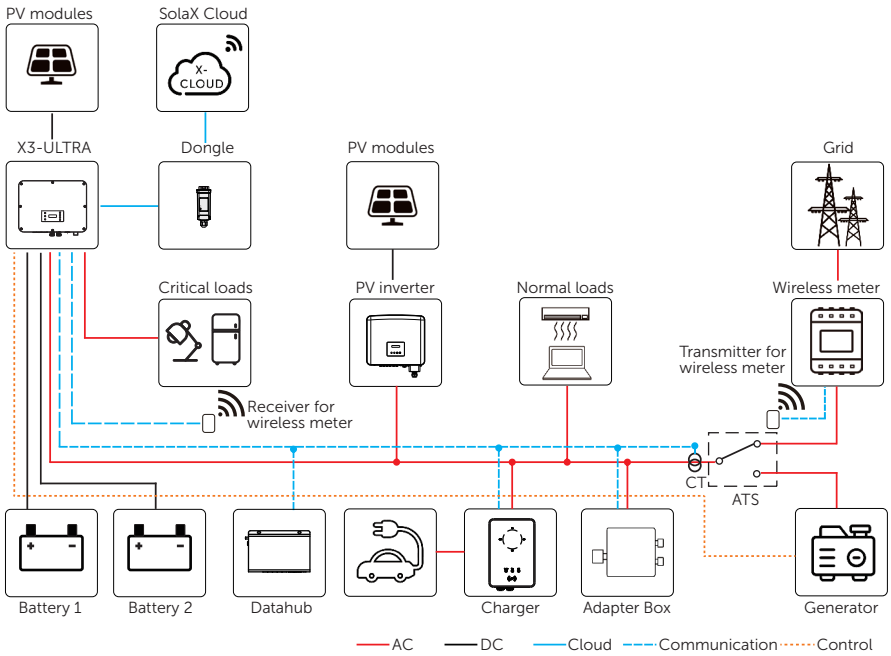

Figure 3-17 System overview diagram

Table 3-8 System item description

Item	Description
X3-ULTRA series (the device covered in this manual)	X3-ULTRA series is an energy storage inverter that supports grid connection of a photovoltaic system.
PV modules	PV modules work in MPPT mode. The maximum number of MPPT is two for 15 kW and 20 kW inverters and three for 25 kW and 30 kW inverters.
Battery	The series inverter should be coupled with lithium-ion battery. Two battery terminals can be connected with two strings of battery. It communicates with the inverter via BMS and must comply with the specifications of the regulations.
Meter/CT	The meter/CT is used by the inverter for import / export or consumption readings, and manages the battery charge / discharge accordingly for smart energy management applications. Wireless meter solution is supported.
Additional on-grid inverter (supported)	The series inverter supports micro-grid function that makes hybrid inverter simulate the grid to active on-grid inverter during off-grid period by connecting on-grid inverter to hybrid inverter's EPS terminal. Please refer to " 15.5 Micro-grid Application " for specific wiring and setting.
Adapter Box G2 (supported)	With SolaX Adapter Box G2, you can connect the smart heat pump to the energy storage systems, realizing the control of the heat pump through inverter. Please refer to " 15.2 Adapter Box Application " for specific wiring and setting.
DataHub (supported)	SolaX DataHub is a professional device that for monitoring platforms of photovoltaic power generation systems, which enables data collection, storage, output control, centralized monitoring, and centralized maintenance of devices such as inverters, electricity meters, and environmental monitoring instruments in photovoltaic power generation systems. Please refer to " 15.4 Datahub Application " for specific wiring and setting.
EV-Charger (supported)	The series inverter can communicate with SolaX EV-Charger to form an intelligent photovoltaic, storage and EV charging energy system, thus maximizing the utilization of photovoltaic energy. Please refer to " 15.3 Application of EV-Charger " for specific wiring and setting.
Generator (supported)	SolaX PV-Genset solution ensures optimum interaction between the photovoltaics and diesel generator, which saves fuel, lowers energy costs and ensures a stable and reliable power supply. Please refer to " 15.1 Generator Application " for specific wiring and setting.
Grid	400 V / 230 V and 380 V / 220 V grid are supported.

SolaX Cloud

SolaX Cloud is an intelligent, multifunctional monitoring platform that can be accessed either remotely or through a hard wired connection. With the SolaX Cloud, the operators and installers can always view key and up to date data.

4 Transportation and Storage

If the inverter is not put into use immediately, the transportation and storage requirements needs to be met:

Transportation

- Observe the caution signs on the packaging of inverter before transportation.
- Pay attention to the weight of inverter. Be cautious to avoid injury when carrying X3-ULTRA (gross weight: 62 kg). Transport according to the personnel quantity required by local regulations.
- Wear protective gloves when carrying the equipment by hand to prevent injuries.
- When lifting up the inverter, hold the handle position and the bottom position of the inverter. Keep the inverter horizontal in case of falling down.

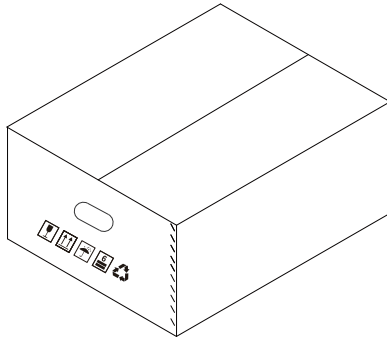

Figure 4-1 Caution signs on the packaging

Storage

- The inverter must be stored indoors.
- Do not remove the original packaging material and check the outer packaging material regularly.
- The storage temperature should be between -40°C and $+70^{\circ}\text{C}$. The humidity should be between 5% and 65%.
- Stack the inverter in accordance with the caution signs on the inverter carton to prevent their falling down and device damage. Do not place it upside down.

5 Preparation before Installation

5.1 Selection of Installation Location

The installation location selected for the inverter is quite critical in the aspect of the guarantee of machine safety, service life and performance. It has the IP66 ingress protection, which allows it to be installed outdoor. The installation position shall be convenient for wiring connection, operation and maintenance.

5.1.1 Environment Requirement

Make sure the installation site meets the following conditions:

- The ambient temperature: -35°C to $+60^{\circ}\text{C}$;
- The relative humidity shall be between 0-100%RH;
- Do not install the inverter in the areas where the altitude exceeds 3000 m;
- Install the inverter in a well-ventilated environment for heat dissipation; You are recommended to install an awning over it if the inverter is installed on a support outdoor;
- Do not install the inverter in areas with flammable, explosive and corrosive materials or near antenna;
- Avoid direct sunlight, rain exposure and snow laying up.

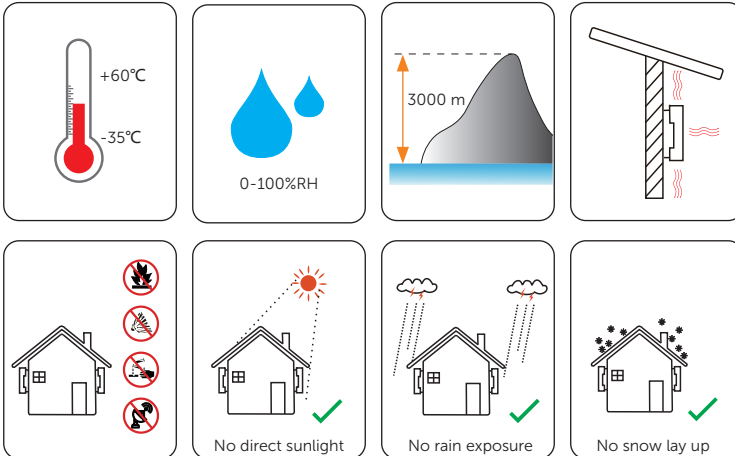

- Install the inverter at least 500 meters away from the coast and avoid sea breeze directly hit.

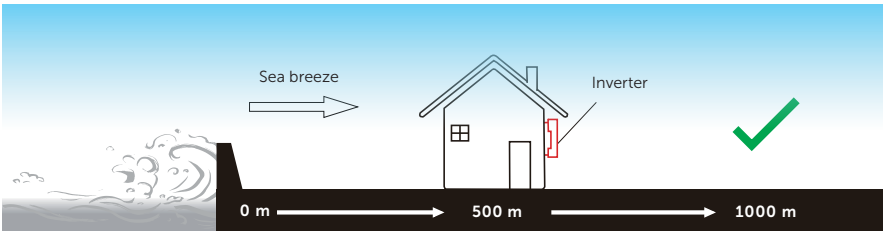

Figure 5-1 Recommended installation position

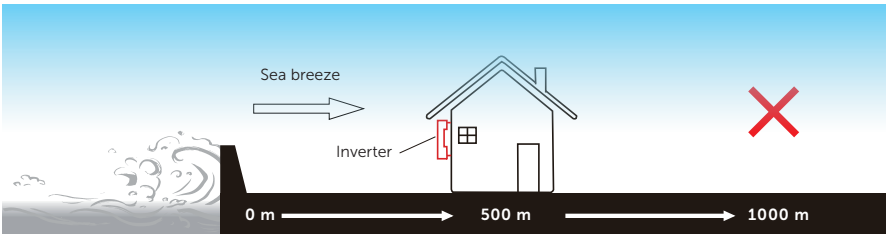

Figure 5-2 Incorrect installation position

NOTICE!

- For the installation of the whole system, please refer to the specific environment requirement of each unit.

5.1.2 Installation Carrier Requirement

The installation carrier must be made of a non-flammable material, such as solid brick, concrete, etc. and be capable of supporting the weight of the inverter and suitable of the dimensions of the inverter. If the wall strength is not enough, (such as wooden wall, the wall covered by thick layer of decoration) it must be strengthened additionally.

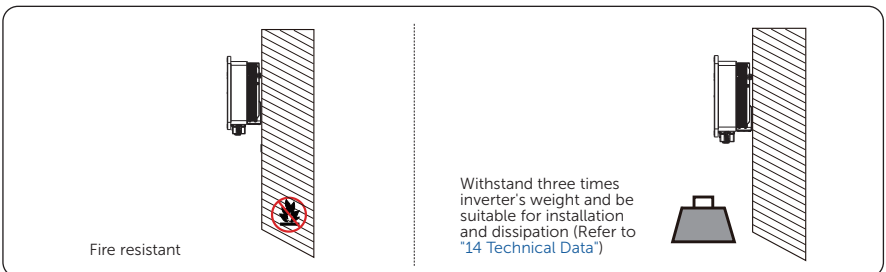

Figure 5-3 Installation carrier requirement

NOTICE!

- Please take the weight of battery into account when wall-mounting the whole system.

5.1.3 Clearance Requirement

The minimum clearance reserved for the connected terminal at the bottom of inverter should be 10 cm. When planning installation space, it is important to simultaneously consider the bending radius of the wires.

To guarantee proper heat dissipation and ease of disassembly, the minimum space around the inverter must meet the standards indicated below.

For installations with multiple inverters, make sure to leave a minimum space of 30 cm between each inverter. In areas with high ambient temperatures, increase the clearances between the inverters and provide adequate fresh air ventilation if feasible.

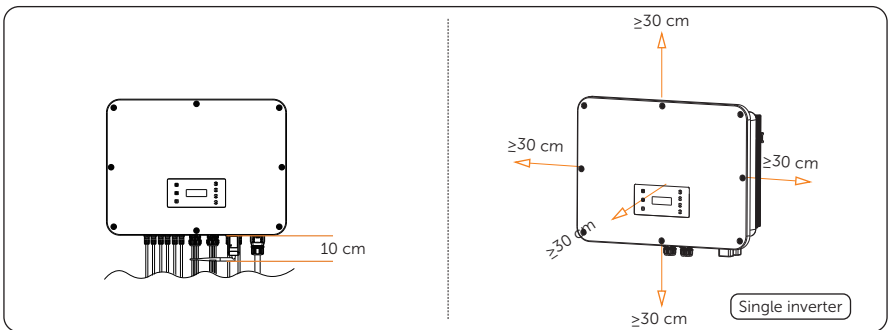

Figure 5-4 Clearance requirement for single inverter

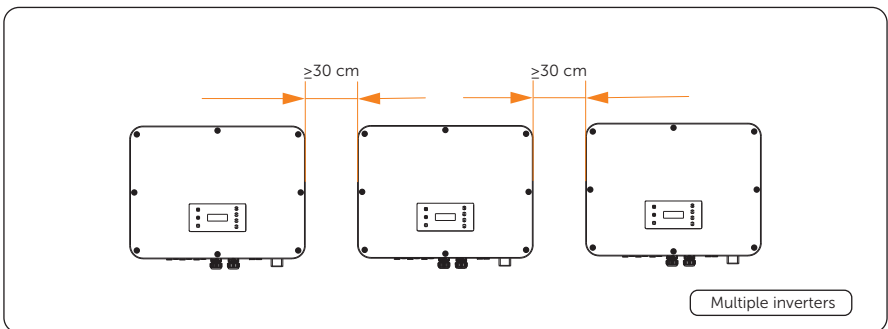

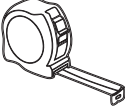

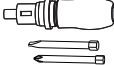

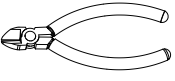

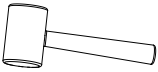
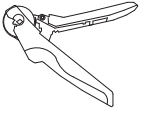
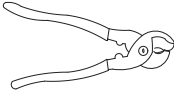
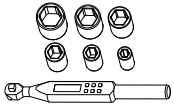
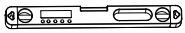
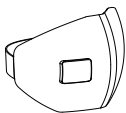





Figure 5-5 Clearance requirement for multiple inverter

5.2 Tools Requirement

Installation tools include but are not limited to the following recommended ones. If necessary, use other auxiliary tools on site. The following tools must all comply with regulatory requirements.

 <p>Hammer drill (drill bit: Ø12 mm)</p>	 <p>Multimeter (≥ 1100 V DC)</p>	 <p>Measuring tape</p>	 <p>Utility knife</p>
 <p>Marker</p>	 <p>Torque screwdriver (Flat-head: M2) (Phillips head: M2.5 / M3 / M5)</p>	 <p>Ø2 mm Flat-head screwdriver</p>	 <p>Diagonal pliers</p>
 <p>Wire stripper</p>	 <p>Crimping tool for RJ45</p>	 <p>Crimping tool for PV terminals</p>	 <p>Rubber mallet</p>
 <p>Crimping tool</p>	 <p>Crimping tool for ferrules</p>	 <p>Wire cutter</p>	 <p>Torque wrench</p>
 <p>Spirit level</p>	 <p>Heat gun</p>		
 <p>Anti-dust mask</p>	 <p>Safety gloves</p>	 <p>Safety boots</p>	 <p>Safety goggles</p>

5.3 Additionally Required Materials

Table 5-9 Additionally required wires





No.	Required Material	Type	Conductor Cross-section
1	PV wire	 Dedicated PV wire with a voltage rating of 1000 V, a temperature resistance of 105 C , a fire resistance grade of VW-1	4 mm ² -6 mm ²
2	Communication wire 1	 Network cable CAT5E / CAT6	/
3	Communication wire 2	 Four-core signal cable	0.25 mm ² -0.3 mm ²
4	Grid and EPS wire	 Five-core copper cable	10 mm ² / 16 mm ²
5	Additional PE wire	 Conventional yellow and green wire	Consistent with Grid and EPS wire

Table 5-10 Micro-breaker recommended for Grid connection



Model	X3-ULT-15KP	X3-ULT-15K	X3-ULT-19.9K	X3-ULT-20K	X3-ULT-20KP	X3-ULT-25K	X3-ULT-30K
Micro-breaker 	32 A	32 A	50 A	50 A	50 A	63 A	63 A

Table 5-11 Micro-breaker recommended for EPS connection

Model	X3-ULT-15KP	X3-ULT-15K	X3-ULT-19.9K	X3-ULT-20K	X3-ULT-20KP	X3-ULT-25K	X3-ULT-30K
Micro-breaker 	32 A	32 A	40 A	40 A	40 A	63 A	63 A

6 Unpacking and Inspection

6.1 Unpacking

- The inverter undergoes 100% testing and inspection before shipping from the manufacturing facility. However, transport damage may still occur. Before unpacking the inverter, please check the outer packing materials for damage, such as holes and cracks.
- Unpacking the inverter according to the following figure.

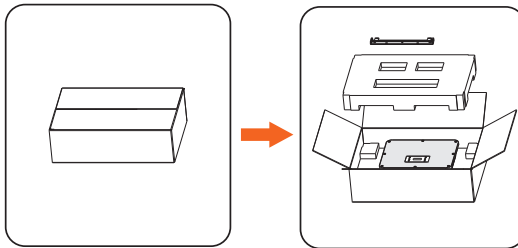

Figure 6-1 Unpacking the inverter

- Be careful when dealing with all package materials which may be reused for storage and relocation of the inverter in the future.
- Upon opening the package, check whether the appearance of the inverter is damaged or lack of accessories. If any damage is found or any parts are missing, contact your dealer immediately.

6.2 Scope of Delivery

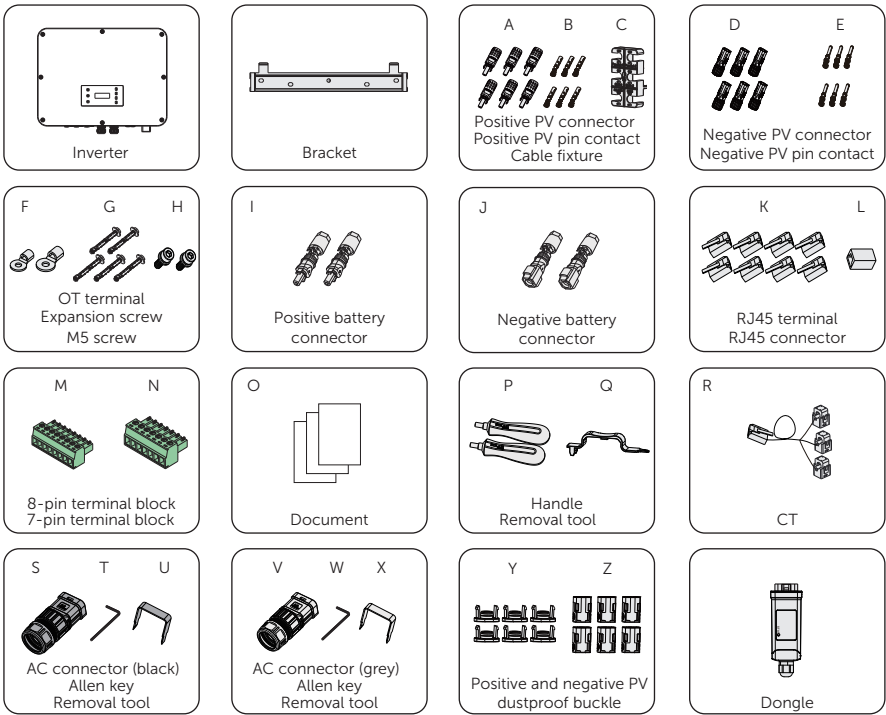

Table 6-1 Packing list

Item	Description	Quantity
/	Inverter	1 pcs
/	Bracket	1 pcs
A	Positive PV connector	6 pairs (4 pairs for X3-ULT-15K, 19.9K and 20K, 6 pairs for X3-ULT-15KP, 20KP, 25K and 30K)
B	Positive PV pin contact	
C	Cable fixture	1 pcs
D	Negative PV connector	6 pairs (4 pairs for X3-ULT-15K, 19.9K and 20K, 6 pairs for X3-ULT-15KP, 20KP, 25K and 30K)
E	Negative PV pin contact	
F	OT terminal	2 pcs (1 pcs for 10 mm ² wire, 1 pcs for 16 mm ² wire)
G	Expansion screw	5 pcs

Unpacking and Inspection

Item	Description	Quantity
H	M5 screw	2 pcs
I	Positive & battery connector	2 pcs
J	Negative battery connector	2 pcs
K	RJ45 terminal	8 pcs
L	RJ45 connector	1 pcs
M	8-pin terminal block	1 pcs
N	7-pin terminal block	1 pcs
O	Document	/
P	Handle	2 pcs
Q	Removal tool (Fast removal of terminals)	1 pcs
R	CT	1 pcs
S	AC connector (black)	1 pcs
T	Allen key	1 pcs
U	Removal tool for AC connector	1 pcs
V	AC connector (grey)	1 pcs
W	Allen key	1 pcs
X	Removal tool for AC connector	1 pcs
Y	Positive PV dustproof buckle	6 pairs (4 pairs for X3-ULT-15K, 19.9K and 20K, 6 pairs for X3-ULT-15KP, 20KP, 25K and 30K)
Z	Negative PV dustproof buckle	
/	Dongle	1 pcs

NOTICE!

- Refer to the actual delivery for the optional accessories.
- The figures of packing list takes 30 kW inverter as an example.

7 Mechanical Installation

WARNING!

- Only the qualified personnel can perform the mechanical installation following the local standards and requirements.
- Check the existing power cables or other piping in the wall to prevent electric shock or other damage.

CAUTION!

- Always be aware of the weight of the inverter. Personal injuries may result if the inverter is lifted improperly or dropped while being transported or mounted.
- Use insulated tools when installing the device. Personal protective equipment must be worn during installation and maintenance.

NOTICE!

- Install the inverter at a maximum back tilt of 5 degrees and avoid forward tilted, side tilted, or upside down.

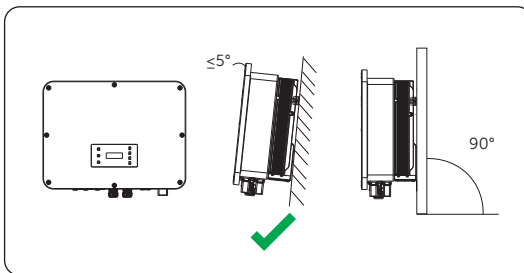

Figure 7-1 Correct installation

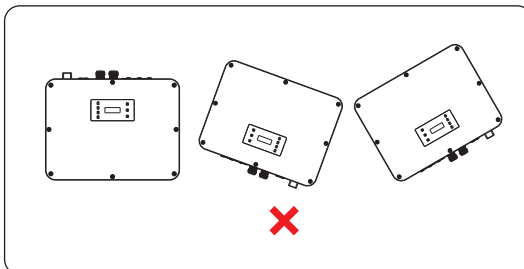

Figure 7-2 Incorrect installation

7.1 Dimensions for mounting

Check the dimensions of the bracket before mounting and reserve sufficient space for heat dissipation and installation of the whole system.

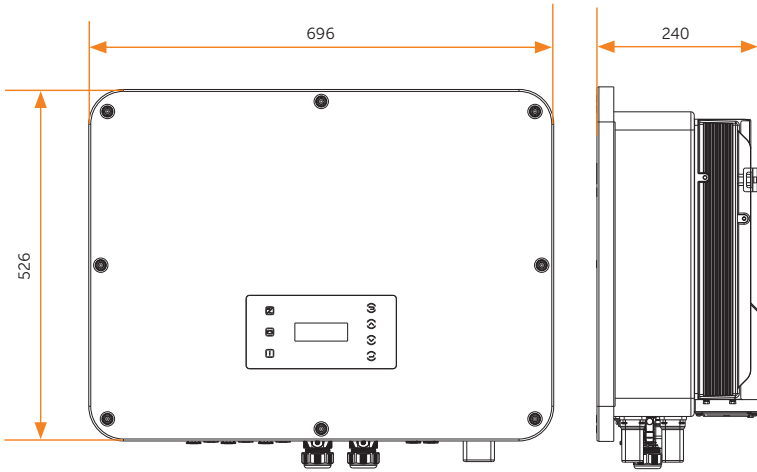

Figure 7-3 Dimensions 1 (Unit: mm)

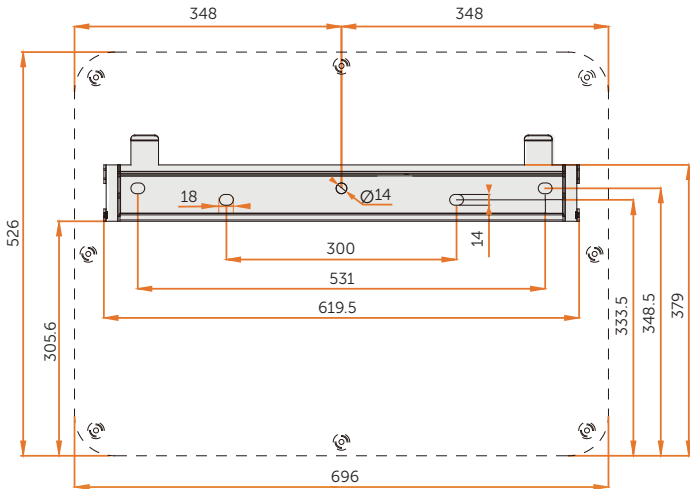

Figure 7-4 Dimensions 2 (Unit: mm)

7.2 Installation procedures

Step 1: Align the bracket horizontally on the wall and mark the position of the drill holes.

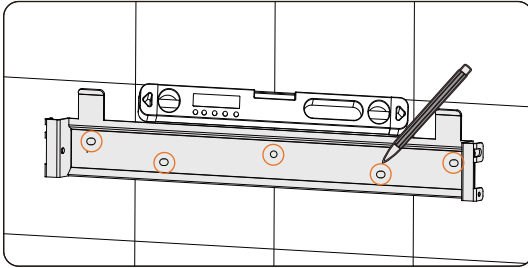

Figure 7-5 Marking the holes

NOTICE!

- Take the height of the stacked battery into account when mounting the bracket.
- Observe the bubble of spirit level and adjust the bracket until the bubble stays in the middle.

Step 2: Set the bracket aside and drill holes with $\varnothing 12$ drill bit. The depth of the holes should be 90 mm.

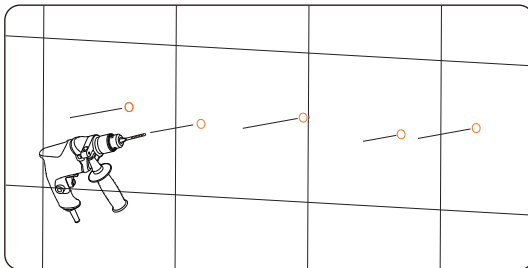

Figure 7-6 Drilling holes

Step 3: Knock the expansion screws (part G) into the holes and secure the bracket to the wall with screws by torque wrench.

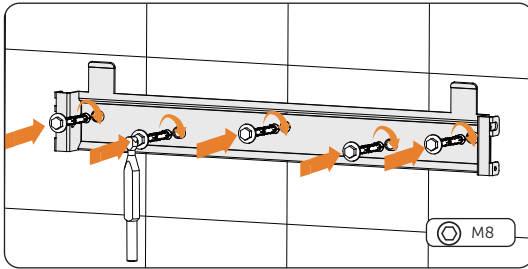

Figure 7-7 Inserting the screws

Step 4: Open the anti-static bag and take out the inverter and install the handle (Part P).

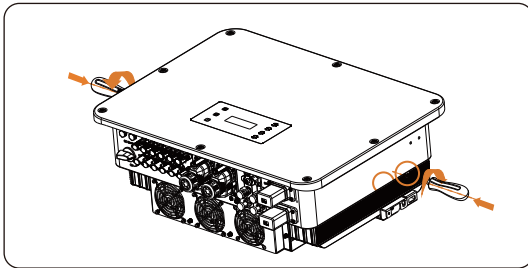

Figure 7-8 Install the handles

NOTICE!

- Avoid placing the inverter in a way that the wiring terminals are in contact with the floor or any other objects as they are not designed to bear the weight of the inverter.
- If the inverter is temporarily needed to be placed on the ground, use foam or other protective materials to prevent any damage of inverter.

Step 5: Lift the inverter by the handles and hang it on the bracket. The buckle on the bracket must be hooked into the keyways of the inverter. And then remove the handles.

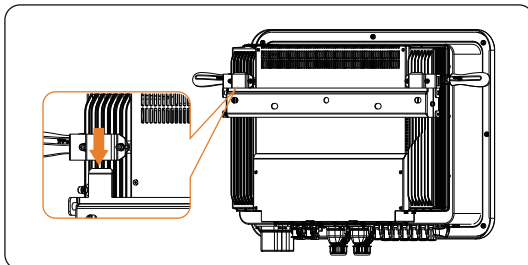

Figure 7-9 Hanging the inverter

Step 6: Secure the inverter to the bracket with M5 screw (part H).

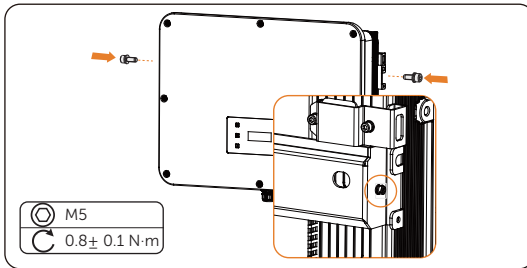

Figure 7-10 Securing the inverter

Step 7: (Optional) For safety reason, install an anti-theft lock. Please note that the lock is not in the scope of delivery. Prepare it suitable for the lock hole diameter ($\varnothing 10$ mm) by yourself. Keep the key to the lock in a safe place.

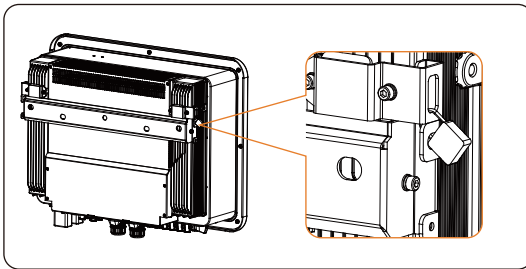

Figure 7-11 Locking the inverter

8 Electrical Connection

DANGER!

- Before electrical connection, make sure the DC switch and AC breaker are disconnected. Otherwise, electrical shock may be caused by high voltage, resulting in serious personal injury or death.

WARNING!

- Only the qualified personnel can perform the electrical connection following the local standards and requirements.
- Follow this manual or other related document to wire connection. The device damage caused by incorrect cabling is not in the scope of warranty.
- Use insulated tools and wear individual protective tools when connecting cables.

8.1 Overview of Electrical Connection

8.1.1 Terminals of Inverter

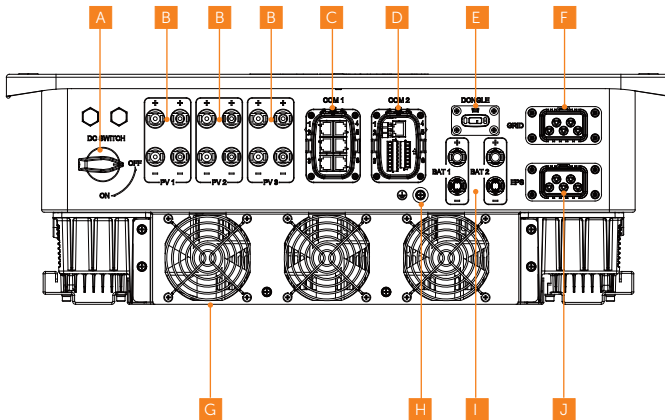

Figure 8-1 Terminals of Inverter

Table 8-2 Description of terminals

Item	Description
A	DC switch
B	PV connection terminal (PV1 and PV2 terminals for X3-ULT-15K, 19.9K and 20K inverter; PV1, PV2 and PV3 terminals for X3-ULT-15KP, 20KP, 25K and 30K inverter)
C	COM 1 communication terminal (including Parallel-1, Parallel-2, BMS-1, BMS-2, RS485, DRM)
D	COM 2 communication terminal (including Ripple control, DIO, Meter/CT)
E	Dongle terminal
F	Grid connection terminal
G	Fans
H	Ground connection point
I	Battery connection terminal
J	EPS connection terminal

8.1.2 Cable Connections of Inverter

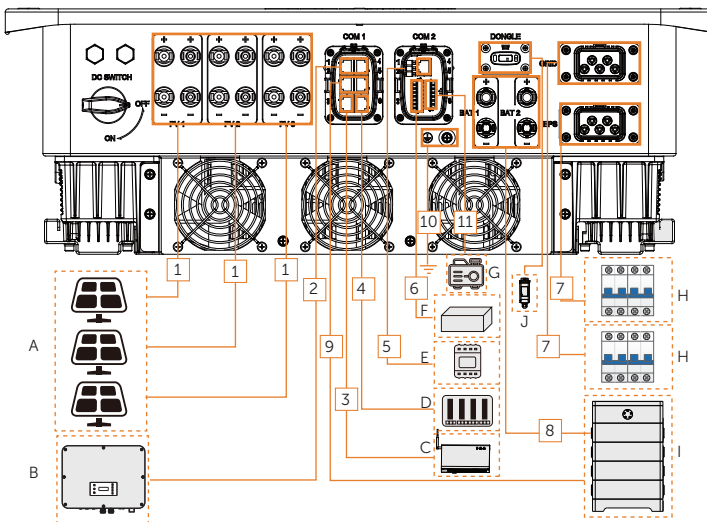

Figure 8-2 Cable connections of inverter

Table 8-3 Descriptions of connected part

Item	Part	Description	Source
A	PV module	A PV string is composed of the PV modules connected in series. The number of input PV strings varies in accordance with different models.	Prepared by user
B	(Optional) X3-ULTRA series inverter	Select a same model of inverter	Purchased from SolaX
C	(Optional) SolaX communication device	SolaX DataHub, Adapter Box G2 and EV-Charger are supported. Select the device as needed.	Purchased from SolaX
D	Power grid scheduling device (only applicable to Australia and New Zealand)	Select the devices that meet the power grid scheduling requirements.	Prepared by user
E	Meter	Supported meter: SolaX authorized DTSU666 and DTSU666-CT.	Purchased from SolaX
F	(Optional) Ripple control receiver	Select the devices that meet the power grid management requirements.	Prepared by user
G	(Optional) Dry contact controlled device	Generator and system switch are supported. For generator, select a generator equipped with an Auto Transformer Switch (ATS), and the rated output power of the generator should be greater than the sum of the load power and the battery charging power. For system switch, select a self-locking switch.	Prepared by user
H	AC switch	Select an appropriate AC switch according to the local regulations to ensure the inverter can be securely disconnected from the grid when an emergency occurs. Refer to "5.3 Additionally Required Materials" for the recommended specifications of AC switch.	Prepared by user
I	Battery	T-BAT-SYS-HV-S2.5/3.6 can be connected with the series inverter.	Prepared by user
J	(Optional) Monitoring dongle	Only SolaX monitoring dongle supported.	Purchased from SolaX

Table 8-4 Descriptions of cables

Item	Cable	Type and specifications	Source
1	PV DC input power cable		Prepared by user
2	RS485 communication cable		Prepared by user
3	RS485 communication cable		Prepared by user
4	RS485 communication cable	Refer to "5.3 Additionally Required Materials".	Prepared by user
5	RS485 communication cable		Prepared by user
6	Signal cable		Prepared by user
7	AC output cable		Prepared by user
8	Battery power cable	/	Delivered with battery
9	Battery communication cable		Prepared by user
10	PE cable	Refer to "5.3 Additionally Required Materials".	Prepared by user
11	Signal cable		Prepared by user

8.2 PE Connection

The inverter must be grounded reliably. The connection point has been labeled with the following label:  We recommend that the inverter is earthed to a nearby ground point.

NOTICE!

- X3-ULTRA series inverter has the grounding detection function which is used to check whether the inverter is properly grounded before it starts. If the the inverter is not connected with earth, the inverter will turn on a red light and report **Earth Fault**.

PE connection procedures

Step 1: Strip the insulation of conductor by wire stripper. Stripping length of 16 mm² wire is 13.5 mm-15.5 mm.

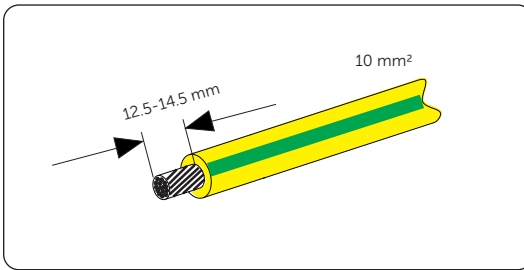

Figure 8-3 Stripping the PE cable

Step 2: Insert the stripped section into the OT terminal(part F).

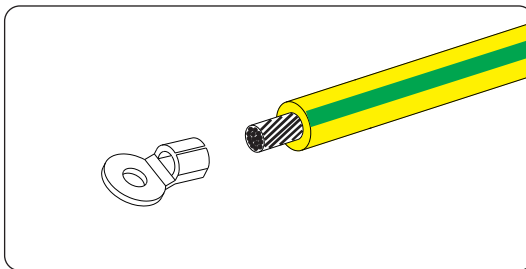

Figure 8-4 Installing the tubing and OT terminal

Step 3: Crimp it with crimping tool.

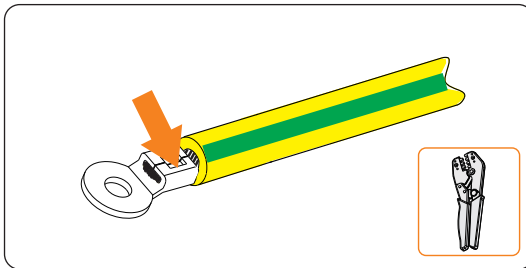

Figure 8-5 Crimping the cable

Step 4: Loosen the PE screw on the inverter with cross screwdriver.

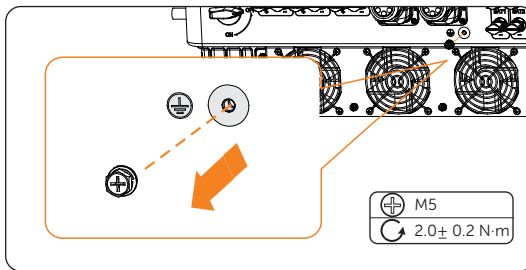

Figure 8-6 Uninstalling the screw

Step 5: Connect the PE cable to the inverter and secure it with the original screw (Torque: 2.0 ± 0.2 N·m).

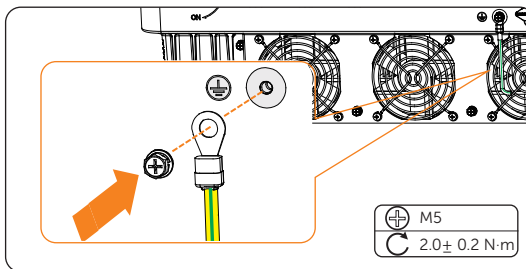

Figure 8-7 Securing the PE cable

8.3 AC Connection

NOTICE!

- Before connecting the inverter to the grid, approval must be received by local utility as required by national and state interconnection regulations.

The inverter has an EPS function. When the grid is connected, the inverter outputs go through the on Grid terminal, and when the grid is disconnected, the inverter outputs go through the EPS terminal.

Requirements for AC connection

- Grid Voltage requirement
 - » The grid voltage and frequency must be within the allowable range (400 V / 230 V, 380 V / 220V, 50 / 60 Hz) and comply with the requirements of the local power grid.
- Residual Current Device (RCD)
 - » The inverter does not require an external RCD when operating. If an external RCD is required by local regulations, a 300 mA Type-A RCD is recommended. If required by local regulations, a Type-B RCD is also permitted.
- AC breaker
 - » An AC breaker that matches the power of the inverter must be used between the inverter output and the power grid. Each inverter must be equipped with an independent breaker or other load disconnection unit to ensure the safe disconnection from the grid. For specific information on the AC breaker for Grid and EPS, see "5.3 Additionally Required Materials".
- EPS load
 - » Make sure that the rated power of the EPS load is within the rated output power range of the inverter. Otherwise, the inverter will report an Overload Fault alarm. In this case, turn off some loads to suit the rated EPS output power range of the inverter, and then press the ESC key on the LCD screen to clear the fault.
 - » When connecting to the EPS terminal, pay attention to the following points:

Medical equipment	Connection prohibited
Precision instrument	Connection prohibited
Appliances susceptible to malfunctions in the event of power outages during use.	Connection prohibited

- » For inductive loads such as refrigerators, air conditioner, washing machine, etc., ensure that their start power does not exceed the EPS peak power of the inverter.

Table 8-5 EPS load information

Type of load	Equipment	Start power
Resistive load	Lamp	Rated power
	Fan	Rated power
	Hair dryer	Rated power
	Refrigerator	3-5 times rated power
Inductive load	Air conditioner	3-6 times rated power
	Washing machine	3-5 times rated power
	Microwave oven	3-5 times rated power

* Refer to the start power of the equipment for the actual start power.

Wiring procedures

NOTICE!

- This section takes the wiring of the Grid terminal for example. It is also applicable to the wiring of the EPS terminal.

Step 1: Prepare a five-core cable as the Grid cable and strip the insulation of L1, L2, L3, N and the grounding conductor to an appropriate length.

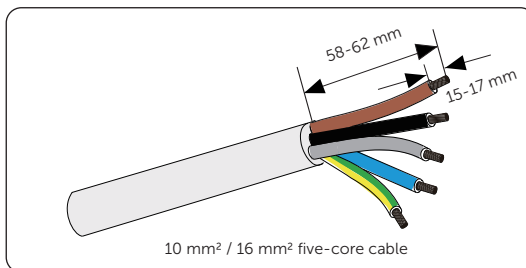

Figure 8-8 Stripping the Grid cable

Step 2: Disassemble the AC connector (part S, part V for EPS terminal) as below. Remove rubber plugs based on the actual wire diameter.

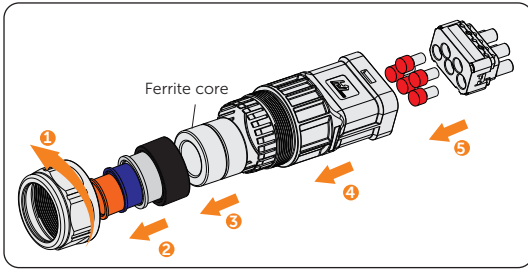

Figure 8-9 Disassembling the AC connector

Step 3: Thread the Grid cable through swivel nut and connector enclosure in sequence.

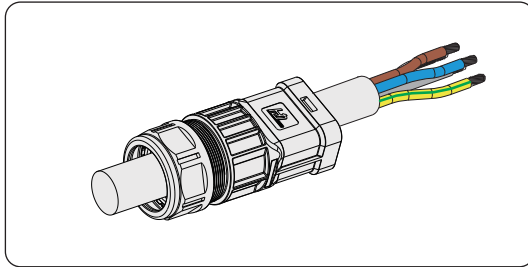

Figure 8-10 Threading the Grid cable

Step 4: Insert the conductors L1, L2, L3, N, and grounding conductor into the ferrules. Use crimping tool for ferrules to crimp it. Make sure the conductors are correctly assigned and firmly seated in the ferrules.

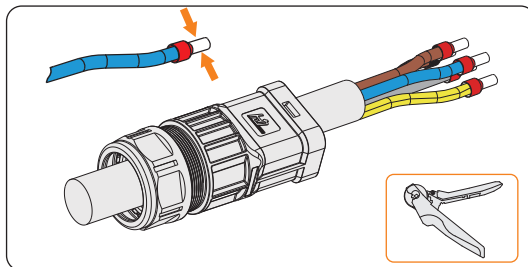

Figure 8-11 Stripping the end of cable and crimping it

Step 5: Insert the crimped conductors L1, L2, L3, N, and grounding conductor into the terminal block according to the labeling and tighten the terminal block screws with Allen key (part T).

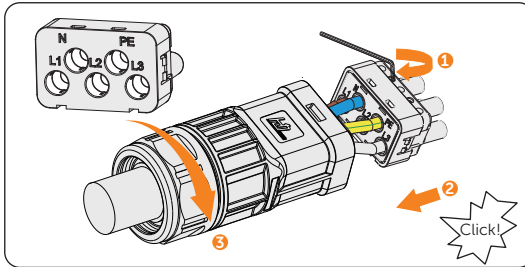

Figure 8-12 Assembling the AC connector

Step 6: Remove the AC terminal caps and plug the assembled AC connectors into Grid terminal and EPS terminal correspondingly.

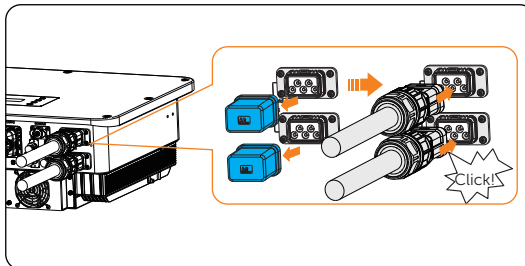

Figure 8-13 Installing the AC connector to inverter

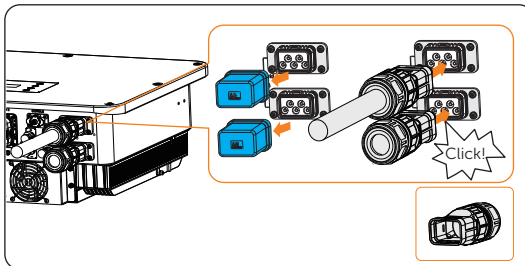

Figure 8-14 The EPS terminal is not connected

! DANGER!

- Before powering on the inverter, make sure the AC connectors are properly installed correctly on the Grid and EPS terminal even if the EPS terminal is not wired. Otherwise, electrical shock may be caused by high voltage, resulting in serious personal injury or death.

! WARNING!

- Reinstall AC terminal caps immediately after removing the connectors from terminals.

8.4 PV Connection

DANGER!

- When exposed to the sunlight, PV modules will generate lethal high voltage. Please take precautions.
- Before connecting the PV modules, make sure that both DC switch and AC breaker are disconnected, and that the PV module output is securely isolated from the ground.

WARNING!

- To mitigate the risk of fire, it is crucial to utilize a dedicated crimping tool specifically designed for PV installations to ensure secure and reliable connections.

CAUTION!

- Power is fed from more than one source and more than one live circuit.

Requirements for PV connection

- Open circuit voltage and operating voltage
 - » The open circuit voltage of each module array cannot exceed the maximum PV input voltage (1000 V) of the inverter. Otherwise, the inverter may be damaged.
 - » The operating voltage of PV modules must be within the MPPT voltage range (180-950 V) of the inverter. Otherwise, the inverter will prompt a PV Volt Fault alarm. Consider the impact of low temperature on the voltage of the photovoltaic panels, as lower temperatures tend to result in higher voltages.
- PV module
 - » The PV modules within the same MPPT channel are of the same brand. Additionally, the strings within the same channel should have identical quantities, and be aligned and tilted identically.
 - » The positive or negative pole of the PV modules is not grounded.
 - » The positive cables of the PV modules must be connected with positive DC connectors.
 - » The negative cables of the PV modeules must be connected with negative DC connectors.

Wiring procedures

Step 1: Strip approx. 7 mm of the cable insulation.

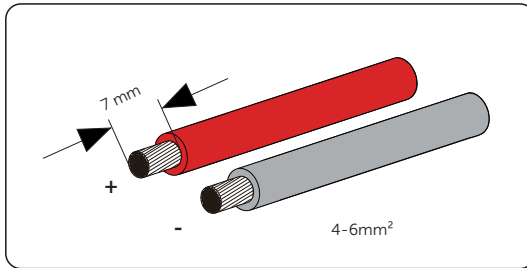

Figure 8-15 Stripping the PV cable

Step 2: Insert the stripped cable into the PV pin contact (part B and part E).

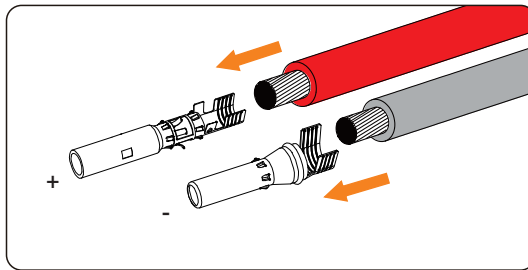

Figure 8-16 Inserting the PV pin contact

Step 3: Make sure the the PV cable and PV pin contact are of the same polarity. Crimp it with crimping tool for PV terminal. Pay attention to the crimping position.

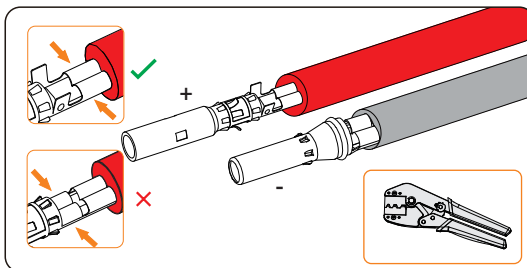

Figure 8-17 Crimping the terminal

Step 4: Thread the PV cable through swivel nut and insert the cable into the PV connector (part A and part D). until a "Click" is heard. Gently pull the cable backward to ensure firm connection. Tighten the swivel nut clockwise. Verify that the PV connectors have the correct polarity before connection.

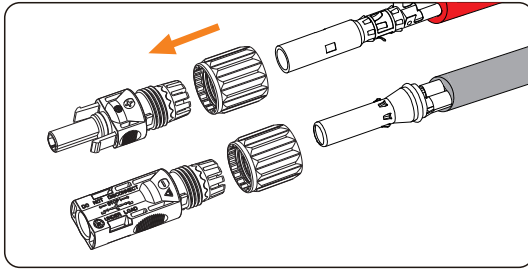

Figure 8-18 Threading the PV cable

Step 5: A "Click" will be heard if it is connected correctly. Gently pull the cable backward to ensure firm connection. Tighten the swivel nut clockwise. Verify that the PV connectors have the correct polarity before connection.

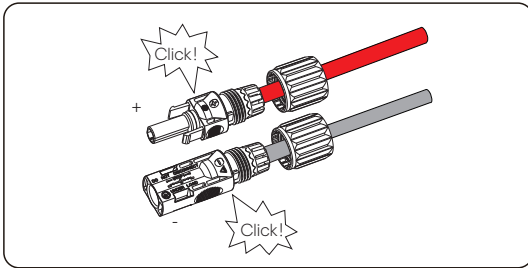

Figure 8-19 Securing the PV cable

Step 6: Use a voltage measuring device which complies with the local regulation to measure the positive and negative voltage of the assembled PV connectors. Make sure the open circuit voltage does not exceed the input limit of 1000 V.

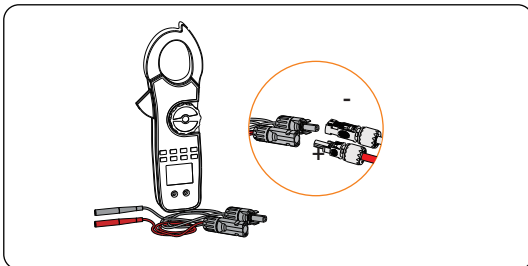

Figure 8-20 Measuring the voltage of PV connectors

NOTICE!

- If the voltage reading is negative, it indicates an incorrect DC input polarity. Please check if the wiring connections on the multimeter is correct or PV connectors are not mistakenly connected.

Step 7: Remove the PV terminals caps and connect the assembled PV connectors to corresponding terminals until there is an audible "Click". The PV+ on the string side must be connected to the PV+ on the inverter side, and the PV- on the string side must be connected to the PV- on the inverter side.

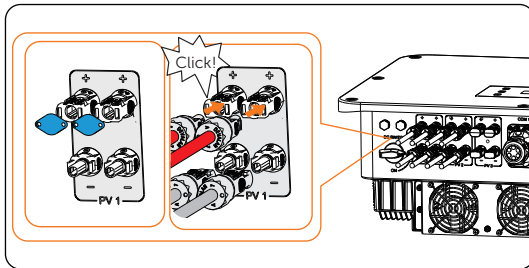

Figure 8-21 Connecting the PV cable

Step 8: (Optional) Fit the unused PV terminals with dustproof buckles (part Y and part Z).

Figure 8-22

8.5 Battery Power Cable Connection



- Before connecting the cables, make sure the breaker, power button (if any) and DC switch (if any) of battery is OFF.
- Always ensure correct polarity. Never reverse the polarity of the battery cables as this will result in inverter damage.

NOTICE!

- The power cable of battery is in the battery accessory pack. NOT in the scope of inverter's delivery.

Requirments for battery connection

- Battery
 - » SolaX Lithium-ion battery
 - » The inverter is equipped with two independent battery terminals, allowing for connection to two separate battery towers. Max charge and discharge current is 30 A for each BAT terminal.
 - » Make sure the input voltage of each BAT terminal is higher than minimum voltage 180 V and lower than maximum input voltage 800 V.
- Micro circuit breaker (MCB)
 - » If the battery is integrated with a readily accessible internal DC breaker, no additional DC breaker is required. If local regulations mandate the use of a DC MCB between the battery and the inverter, install a non-polar DC MCB.
 - » Nominal voltage of DC breaker should be larger than maximum voltage of battery.
 - » See the documentation of battery for the current. For T-BAT-SYS-HV-S2.5/3.6, the current should be 32 A. For T-BAT-SYS-HV-5.8, the current should be 40 A.
- Battery configuration information
 - » For T-BAT-SYS-HV-S2.5, each battery string of one BAT terminal supports 4-13 packs (10.0 kWh to 65 kWh).
 - » For T-BAT-SYS-HV-S3.6, each battery string of one BAT terminal supports 4-13 packs (14.4 kWh to 93.6 kWh).
 - » For T-BAT-SYS-HV-5.8, each battery string of one BAT terminal supports 2-4 packs (11.6 kWh to 46.4 kWh).

NOTICE!

- When the number of T-BAT-SYS-HV-S2.5/3.6 battery modules in one string exceed nine sets (including nine), these battery modules should be installed in two towers, and the Series Box should be installed to connect two towers in series.

- The battery connection scheme.

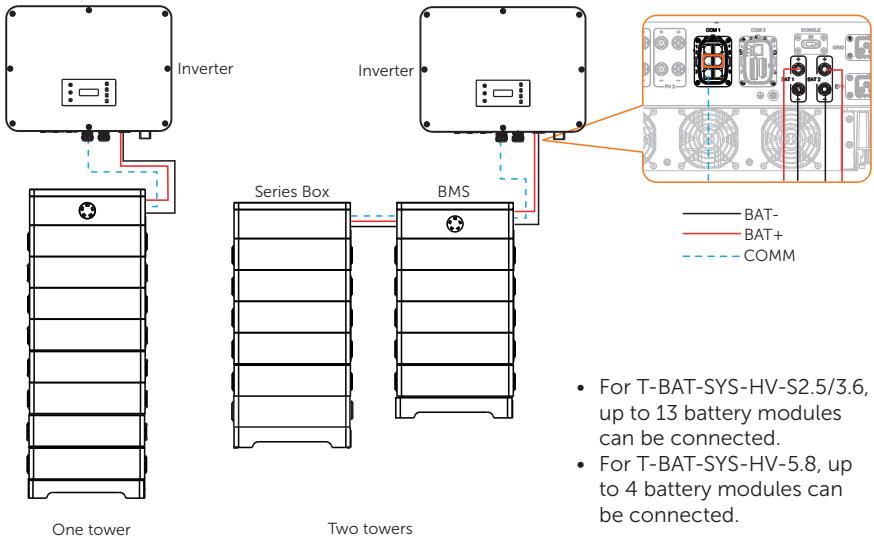

- For T-BAT-SYS-HV-S2.5/3.6, up to 13 battery modules can be connected.
- For T-BAT-SYS-HV-5.8, up to 4 battery modules can be connected.

Figure 8-23 Battery connection in one string

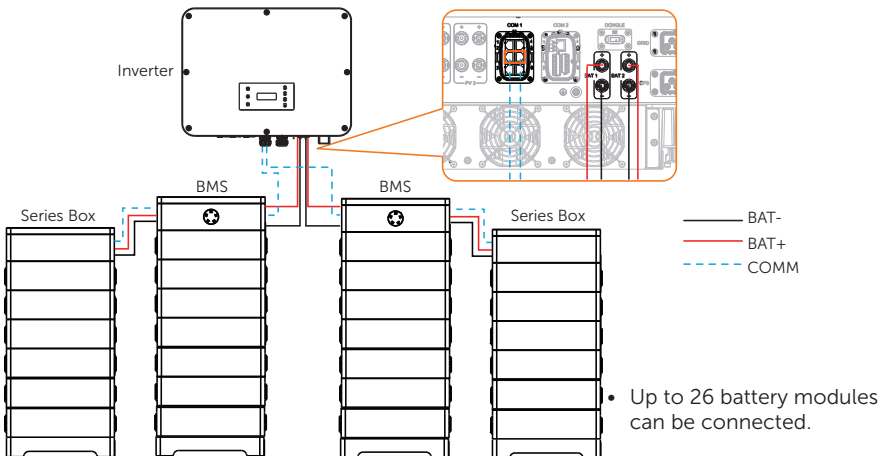

- Up to 26 battery modules can be connected.

Figure 8-24 Battery connection in two strings (T-BAT-SYS-HV-S2.5/3.6)

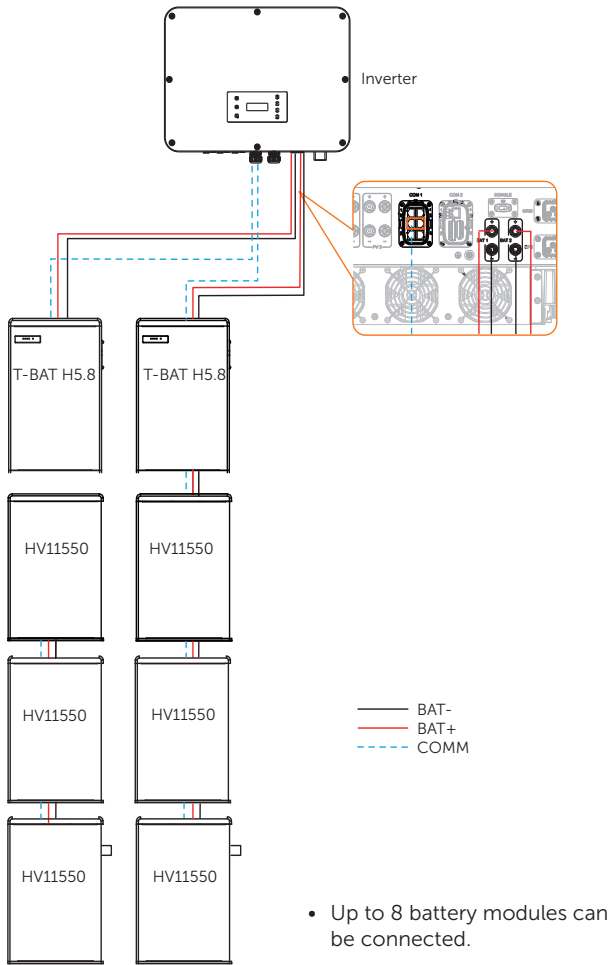

Figure 8-25 Battery connection in two strings (T-BAT-SYS-HV-5.8)

- » Battery connection with BMS-Parallel Box-II G2 (The BMS-Parallel Box-II G2 can be used with T-BAT-SYS-HV-5.8)



Figure 8-26 Battery connection with BMS-Parallel Box-II G2

NOTICE!

- Considering factors such as cost, maximizing battery performance, and meeting the voltage requirements of the inverter, please choose a suitable battery connection scheme.
- It is possible to expand the capacity by adding batteries of the same model, Different models of batteries are not supported for expansion.

Wiring procedures



- Do not remove the terminal caps of unused terminals. Reinstall the caps after removing the connectors from the terminals.

Step 1: Strip approx. 15 mm of the cable insulation.

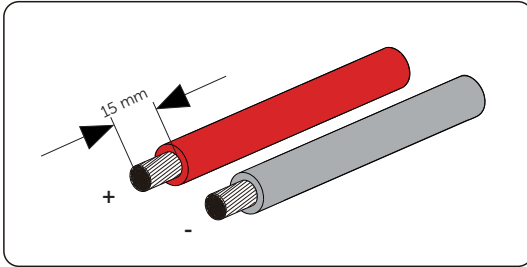

Figure 8-27 Stripping the battery cable

Step 2: Open the spring. Insert the stripped wire with twisted litz wires all the way into the battery connector (part I and part J).

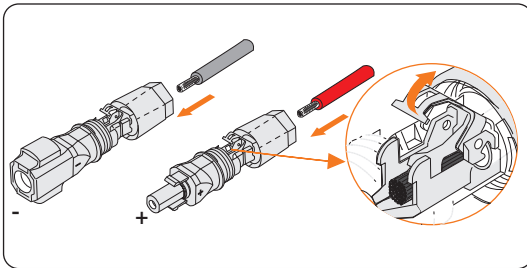

Figure 8-28 Opening the spring

Step 3: The litz wire ends have to be visible in the spring.

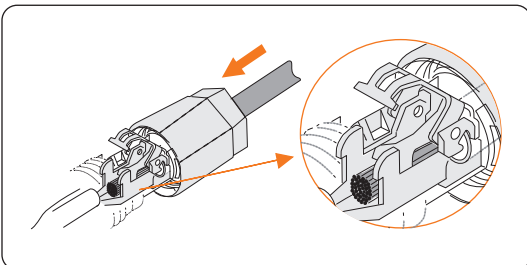

Figure 8-29 Threading the battery cable

Step 4: Close the spring until a "Click" is heard. Make sure that the spring is snapped in.

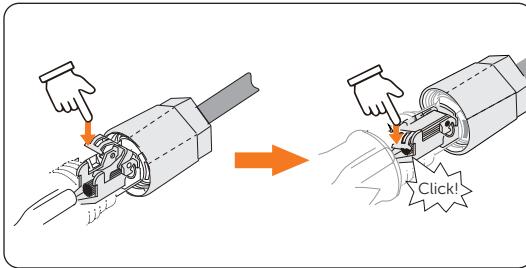

Figure 8-30 Press down on the Spring

Step 5: Push the insert into the sleeve. Tighten the cable gland to 2.0 ± 0.1 Nm.

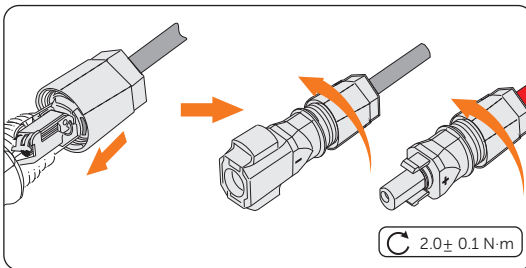

Figure 8-31 Tighten the cable gland

Step 6: Remove the battery terminal caps and connect the assembled battery connectors to corresponding terminals until there is an audible "Click".

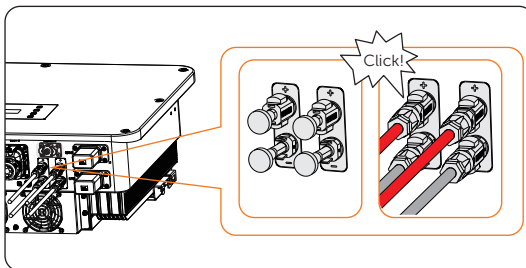
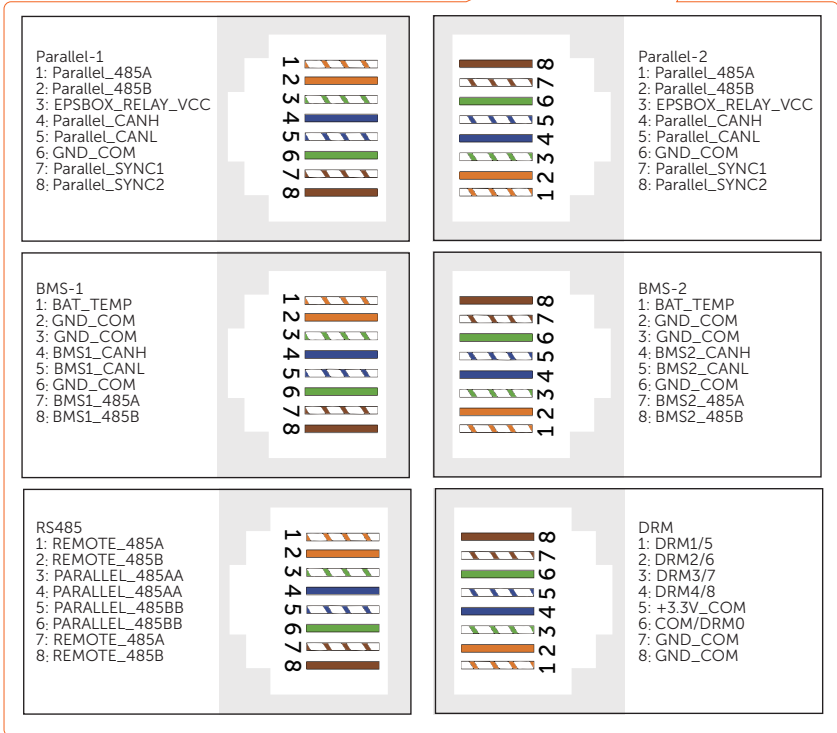
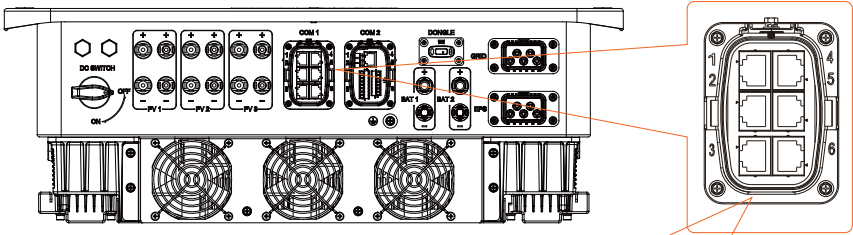

Figure 8-32 Connecting the battery connector

8.6 COM 1 Communication Connection

8.6.1 Pin Assignment of COM 1 Terminal

The COM 1 terminal is used for parallel connection via Parallel-1 and Parallel-2 communication terminal, battery communication via BMS-1 and BMS-2 terminal, Communicate via RS485 and DRM, or external communication.



8.6.2 Parallel Communication Connection

The inverter provides the parallel connection function. One inverter will be set as the "Master inverter" to control the other "Slave inverters" in the system.

NOTICE!

- The communication cable length between two parallel inverters should not exceed 10 meters, and the total cable length of all parallel inverters should not exceed 80 meters.

Table 8-6 Maximum number of inverter paralleled

Application	X3- ULT- 15KP	X3- ULT- 15K	X3- ULT- 19.9K	X3- ULT- 20K	X3- ULT- 20KP	X3- ULT- 25K	X3- ULT- 30K
With X3-EPS Parallel BOX	10	10	7	7	7	6	5
Without X3-EPS Parallel BOX				3			

Parallel connection wiring procedure

Step 1: Loosen the securing screw on COM 1 connector, and then hold the latches on both sides of the connector to pull it out from the enclosure.

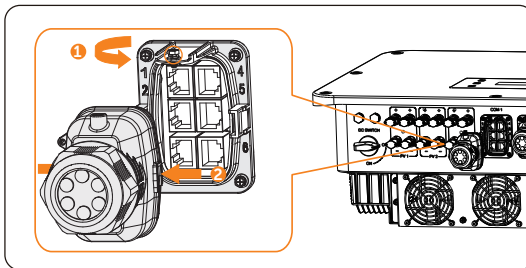

Figure 8-33 Removing the connector enclosure

Step 2: Anti-clockwise loosen the swivel nut and pull out the sealing plugs. Keep them still in the cable support sleeve if you choose not to connect the cable.

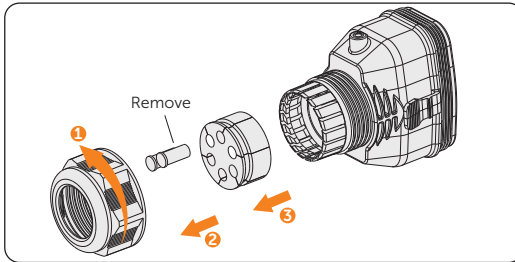

Figure 8-34 Disassembling the connector

Step 3: Thread the cable through the swivel nut, cable support sleeve, and connector enclosure in sequence.

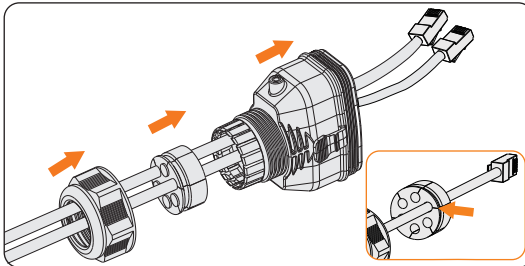

Figure 8-35 Threading the cables

Step 4: Install the network cables to Parallel-1 and Parallel-2 of cable fixture (part C) according to the labeling.

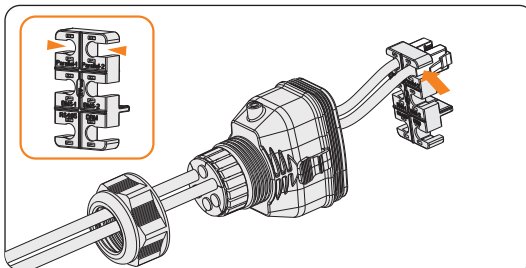

Figure 8-36 Installing RJ45 terminal to the cable fixture

Step 5: Connect the connector to COM 1 terminal. Ensure the cable fixture tongue is well inserted into the slot of terminal. You will hear an audible "Click".

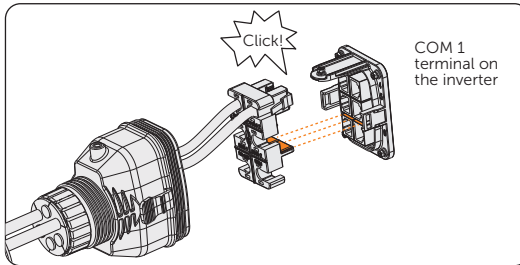

Figure 8-37 Inserting the connector to COM 1

- Step 6:** Secure the assembled connector on COM 1 terminal.
- Install the connector enclosure back into the COM 1 terminal.
 - Install the cable support sleeve into the enclosure.
 - Tighten M3 screw to secure it. (Torque: $0.4 \pm 0.1 \text{ N}\cdot\text{m}$)
 - Clockwise tighten the swivel nut to finish the COM 1 wiring connection.

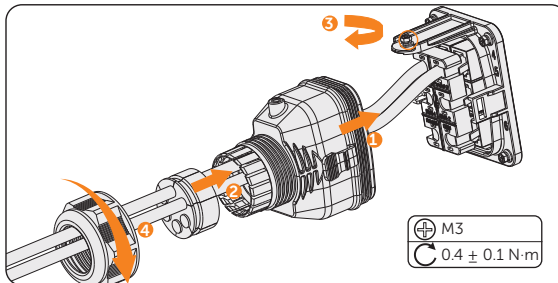

Figure 8-38 Securing the connector

8.6.3 BMS Communication Connection

Through BMS-1 and BMS-2 communication terminal, the inverter can be connected to two independent batteries of different capacities. The model of each battery string must be the same.

BMS connection diagram

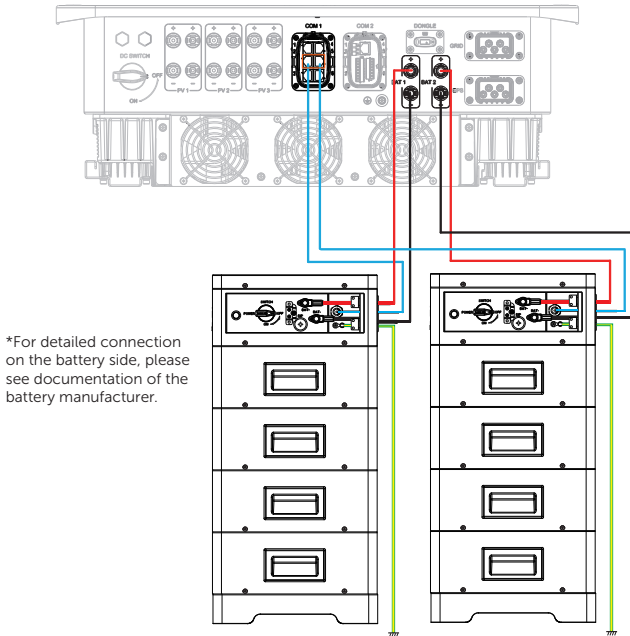

Figure 8-39 BMS connection diagram

BMS wiring procedure

- Step 1:** Loosen the screws on the COM 1 terminal. Pinch the tabs on the sides of the COM 1 connector enclosure and pull it at the same time to remove it.
- Step 2:** Anti-clockwise loosen the swivel nut and pull out the sealing plugs. Keep them still in the cable support sleeve if you choose not to connect the cable.
- Step 3:** Thread the cable through the swivel nut, cable support sleeve, and connector enclosure in sequence.
- Step 4:** Install the network cables to BMS-1 and BMS-2 of cable fixture (part C) according to the labeling.

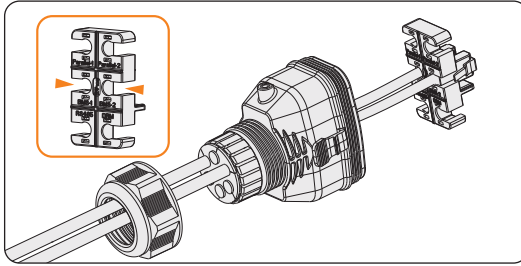

Figure 8-40 Installing RJ45 terminal to the cable fixture

- Step 5:** Connect the assembled connector to COM 1 terminal. Make sure the cable fixture part is well inserted into the slot of terminal. You will hear an audible "Click" if it is connected securely. Lightly pull the cable backward for double check its connection.
- Step 6:** Secure the assembled connector on COM 1 terminal.

8.6.4 RS485 Communication Connection

For SolaX products, such as the Adapter Box, EV-Charger, and Datahub they can be connected to pin3 and pin 6 or pin4 and pin5. As for pin1, pin2, pin7,and pin8 they can be utilized to connect devices other than SolaX products. If you require simultaneous connections of multiple devices, a splitter adapter can be employed.

NOTICE!

- Please refer to "15 Appendix" for the specific application of Adapter Box, EV-Charger and Datahub.
- The cable length of RS485 communication should not exceed 100 meters.
- Not all devices are compatible with 8 pin network cables. In cases where 8 pin network cables are not supported, it is required to re-crimp the RJ45 terminal according to the pin assignment.

External equipment wiring procedure

Step 1: Loosen the screws on the COM 1 terminal. Pinch the tabs on the sides of the COM 1 connector enclosure and pull it at the same time to remove it.

Step 2: Anti-clockwise loosen the swivel nut and pull out the sealing plugs. Keep them still in the cable support sleeve if you choose not to connect the cable.

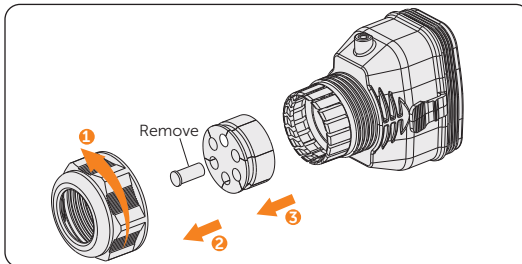

Figure 8-41 Disassembling the connector

Step 3: Thread the cable through the swivel nut, cable support sleeve, and connector enclosure in sequence. The communication cable requires cutting off the existing connector and re-crimping the RJ45 terminal(part K).

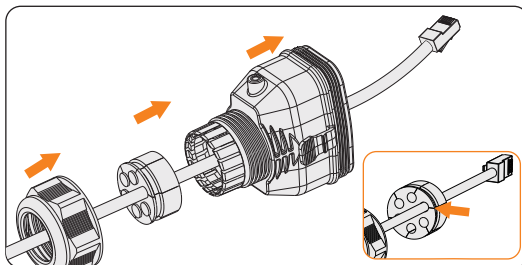

Figure 8-42 Threading the cables

Step 4: Install the network cable to RS485 of cable fixture (part C) according to the labeling.

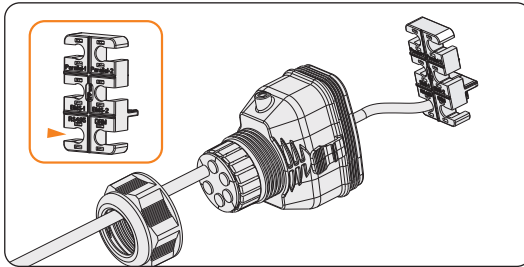

Figure 8-43 Installing RJ45 terminal to the cable fixture

Step 5: Connect the assembled connector to COM 1 terminal. Make sure the cable fixture tongue is well inserted into the slot of terminal. You will hear an audible "Click" if it is connected securely. Lightly pull the cable backward for double check its connection.

Step 6: Secure the assembled connector on COM 1 terminal.

8.6.5 DRM Connection (Applicable to AS/NZS 4777)

According to AS/NZS 4777.2, the inverter needs to support the function of demand response mode (DRM). With the use of an external control box, active or reactive power regulation can be realized in a timely and fast manner, and the inverter can be operated stably during the process of regulation.

DRM 0, DRM 1 and DRM 5 are available now.

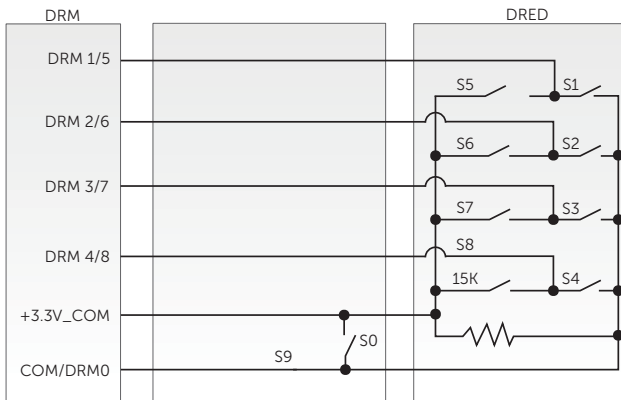

Figure 8-44 DRED wiring diagram

Table 8-7 Descriptions of DRM

Mode	Pin location	Requirement
DRM 0	Pin 6	<ul style="list-style-type: none"> When S0 is turned on, the inverters shut down. When S0 is turned off, the inverters restore grid connection..
DRM 1	Pin 1	<ul style="list-style-type: none"> When S1 is turned on, the inverters do not input active power.
DRM 5	Pin 1	<ul style="list-style-type: none"> When S5 is turned on, the inverters do not output active power.

DRM connection wiring procedure

- Step 1:** Loosen the screws on the COM 1 terminal. Pinch the tabs on the sides of the COM 1 connector enclosure and pull it at the same time to remove it.
- Step 2:** Anti-clockwise loosen the swivel nut and pull out the sealing plugs. Keep them still in the cable support sleeve if you choose not to connect the cable.
- Step 3:** Thread the cable through the swivel nut, cable support sleeve, and connector enclosure in sequence.
- Step 4:** Install the network cable to RS485 of cable fixture (part C) according to the labeling.

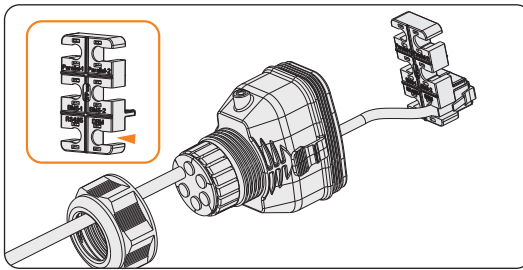

Figure 8-45 Installing RJ45 terminal to the cable fixture

- Step 5:** Connect the assembled connector to COM 1 terminal. Make sure the cable fixture tongue is well inserted into the slot of terminal. You will hear an audible "Click" if it is connected securely. Lightly pull the cable backward for double check its connection.
- Step 6:** Secure the assembled connector on COM 1 terminal.

8.7 COM 2 Communication Connection

8.7.1 Pin Assignment of COM 2 Terminal

The COM 2 terminal is used for Meter/CT connection, ripple control and DIO function.

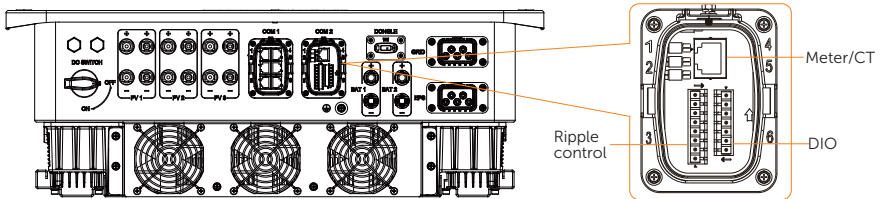

Table 8-8 Pin assignment of COM 2 terminal

Pin	Pin assignment
Meter/CT	
1	CT_R1_CON
2	CT_S1_CON
3	CT_T1_CON
4	METER_485A
5	METER_485B
6	CT_T2_CON
7	CT_S2_CON
8	CT_R2_CON
Ripple control	
1	RP_K4
2	GND_COM
3	RP_K3
4	GND_COM
5	RP_K2
6	GND_COM
7	RP_K1
8	GND_COM

Pin	Pin assignment
DIO port	
1	DO_1
2	DO_2
3	DI_1+
4	DI_1-
5	DI_2+
6	DI_2-
7	GND_COM

8.7.2 Meter/CT Connection

The inverter should work with an electric meter or current transformer (CT for short) to monitor household electricity usage. The electricity meter or CT can transmit the relevant electricity data to the inverter or platform.

 CAUTION!

- The inverter will shut down and prompt **Meter Fault** alarm if meter is not connected to inverter. Smart meters must be authorized by our company. Unauthorized meter and CT may be incompatible with the inverter, resulting in damage to the inverter and working mode malfunction. SolaX will not be responsible for the impact caused by the use of other appliances.

NOTICE!

- Do not place the CT on the N wire or ground wire.
- Do not put CT on the N line and L line at the same time.
- Do not place the CT on the side where the arrow points to the inverter.
- Do not place the CT on non-insulated wires.
- The cable length between CT and inverter should not exceed 100 meters.
- It is recommended to wrap the CT clip around in circles with insulating tape.

Meter/CT Connection Diagram

NOTICE!

- The following figures take inverter with Meter DTSU666 as an example.
- If you have other power generation equipment (such as an inverter) at home and wants to monitor both equipment, our inverter provides Meter 2 communication function to monitor the power generation equipment. For more information, please contact us.
- Please make PE connection for Meter if the meter has ground terminal.

- Meter connection diagram

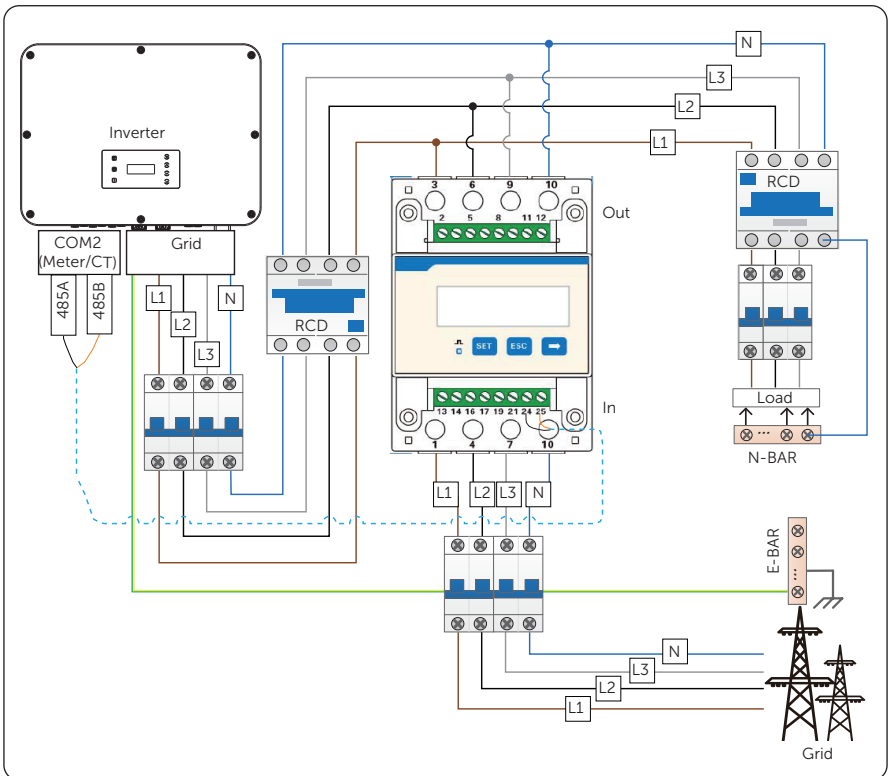

Figure 8-46 Meter connection diagram 1

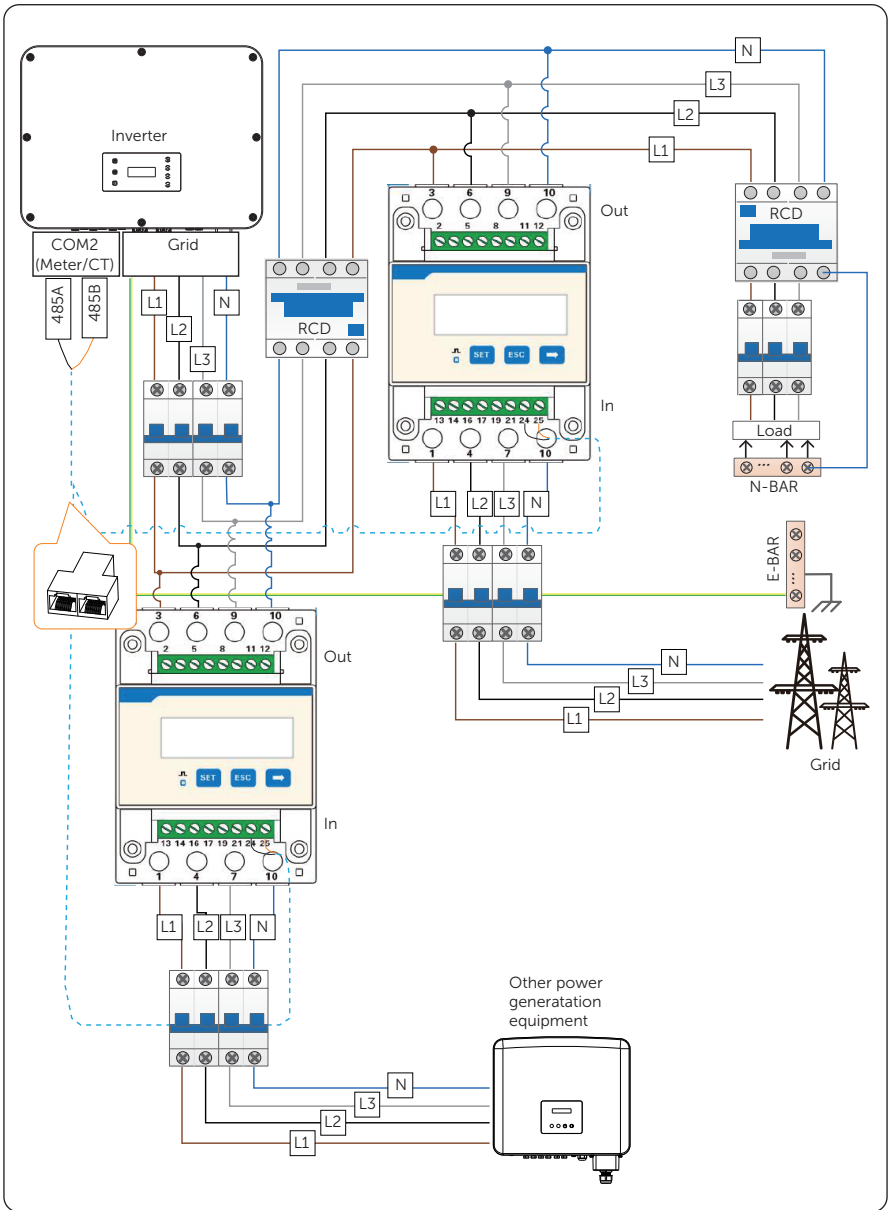

Figure 8-47 Meter connection diagram 2

- Wireless Meter connection diagram

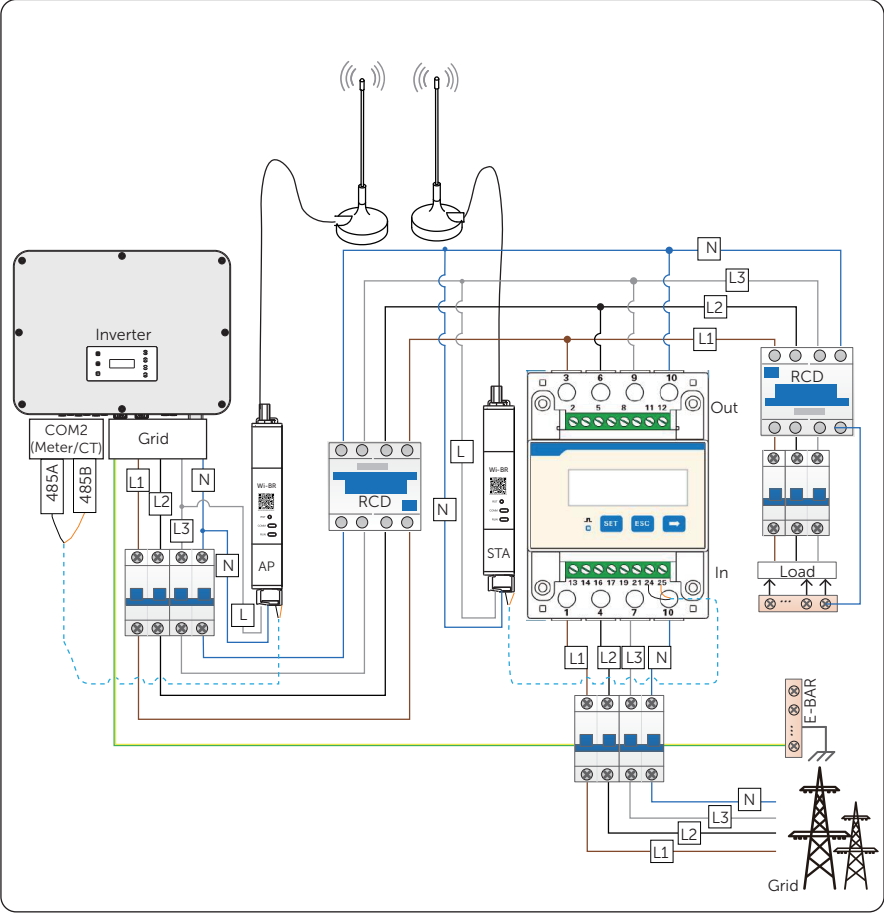

Figure 8-48 Wireless Meter connection diagram

- CT connection diagram

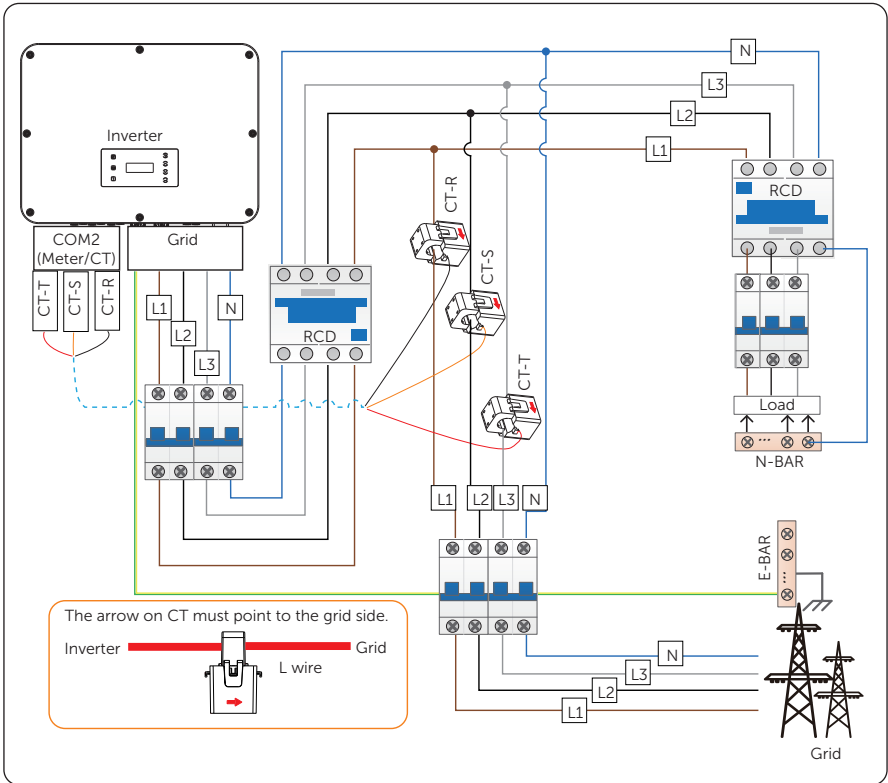

Figure 8-49 CT connection diagram

NOTICE!

- The arrow on the CT must point at the public grid.
- CT-R must be connected to L1, CT-S connected to L2, and CT-T connected to L3 in accordance with the L1, L2 and L3 of the inverter's Grid terminal.

Meter/CT pin definition

	Pin	Pin assignment
For CT connection	1	CT_R1_CON
	2	CT_S1_CON
	3	CT_T1_CON
For Meter connection	4	METER_485A
	5	METER_485B
For CT connection	6	CT_T2_CON
For CT connection	7	CT_S2_CON
	8	CT_R2_CON

Meter/CT wiring procedure

Step 1: Loosen the screws on the COM 2 terminal. Pinch the tabs on the sides of the COM 2 connector enclosure and pull it at the same time to remove it.

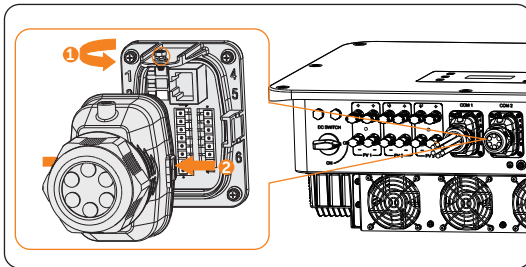

Figure 8-50 Disassembling the COM 2 terminal

Step 2: Loosen the swivel nut on the enclosure, and then remove the sealing plugs from the cable support sleeve as needed. Do not remove the sealing plugs from holes if you choose not to connect the cable.

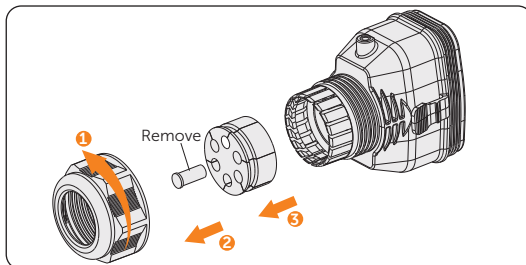

Figure 8-51 Disassembling the connector

Step 3: Thread the cable through the swivel nut, cable support sleeve, and connector enclosure in sequence.

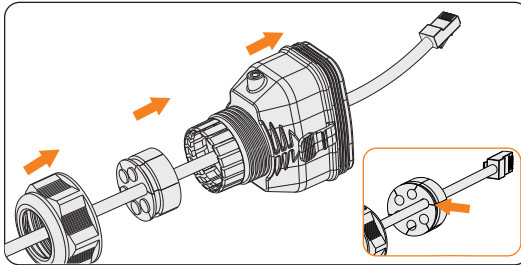

Figure 8-52 Threading the cables

Step 4: Connect the assembled communication cable into the COM 2 terminal. Secure the assembled connector on COM 2 terminal.

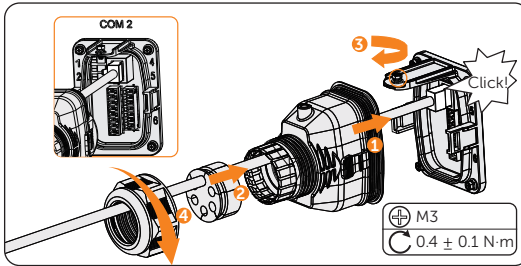

Figure 8-53 Connecting to COM 2

Step 5: For wire meter connection, insert another side of the communication cable into meter. For CT connection, connect the other side to CT (part R).

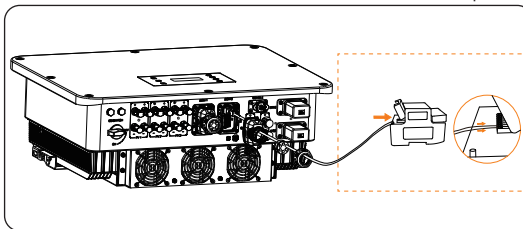

Figure 8-54 Connecting to wire meter

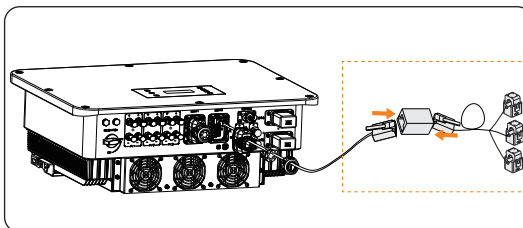

Figure 8-55 Connecting to CT

8.7.3 Ripple Control Communication Connection

Ripple Control is a common form of grid management. Its communication is based on superimposing a very high frequency signal onto the 50 / 60Hz mains power. The inverter supports to connect a digital signal source (e.g. ripple control receiver) to the digital input.

Requirments for Ripple control

- The signal source must be technically suitable for connection to the digital inputs. (see technical data)
- The connected digital signal source has a safe separation to the grid potential.

Connection diagram for ripple control

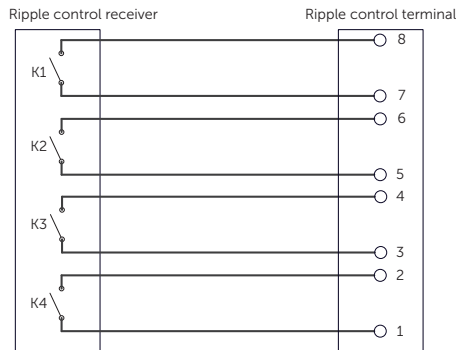

Figure 8-56 Connection diagram for ripple control

Ripple control wiring procedure

- Step 1:** Loosen the screws on the COM 2 terminal. Pinch the tabs on the sides of the COM 2 connector enclosure and pull it at the same time to remove it.
- Step 2:** Loosen the swivel nut on the enclosure, and then remove the sealing plugs from the cable support sleeve as needed. Do not remove the sealing plugs from holes if you choose not to connect the cable.

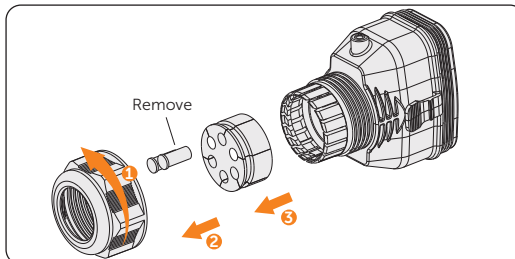

Figure 8-57 Disassembling the connector

Step 3: Strip approx.6 mm of the cable insulation. Insert the conductors into the 8-pin terminal block (part M) and tighten the terminal screws (torque: 1.5 N·m.) Ensure that the conductors are firmly seated in the terminal.

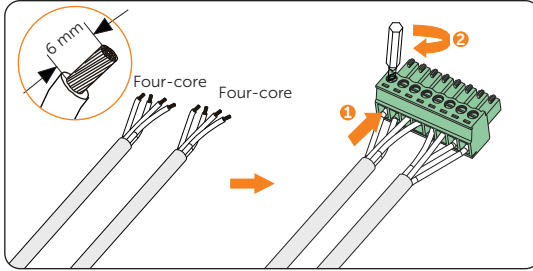

Figure 8-58 Connecting to 8-pin terminal block

Step 4: Connect the assembled communication cable into the COM 2 terminal. Lightly pull the cable backward to confirm tight insertion and then install the connector back.

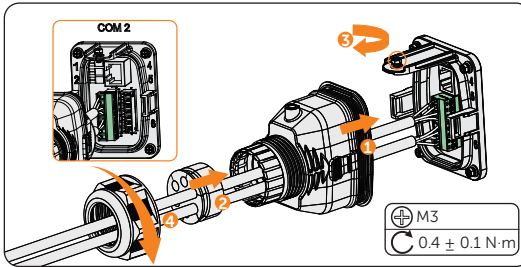

Figure 8-59 Connecting to the inverter

8.7.4 DIO Communication Connection

DIO terminal is designed to communicate with generator and system switch through dry contact.

To enhance safety and reduce the risk of injury, you can install the system switch in a readily accessible location through dry contact connection. In the event of an emergency, the system switch can be easily reached and pressed to promptly switch off the entire system, ensuring a swift response and preventing further harm.

For generator, please refer to ["15.1 Generator Application"](#) for specific application.

DIO pin definition

Application	Pin	Pin assignment
For generator dry contact output	1	DO_1
	2	DO_2

For system switch dry contact input	3	DI_1+
	4	DI_1-
Reserved	5	DI_2+
	6	DI_2-
Reserved	7	GND_COM

NOTICE!

- If there is strong interference in the surroundings, it is recommended to use shielding cables and ground the shielding layer of the cables through Pin 7.

System switch connection diagram

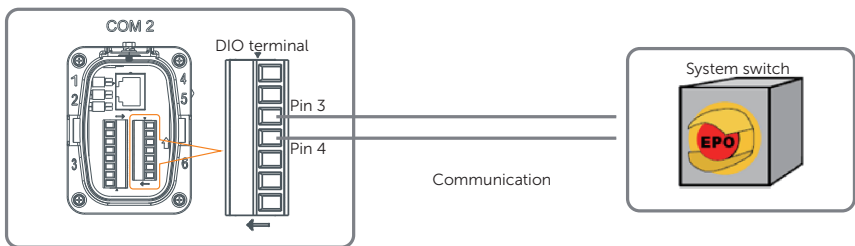

Figure 8-60 System switch connection diagram

When system switch is pressed, **OFF MODE (DIO SW)** will be displayed on the LCD screen and the system will be powered off. To release the switch, press it again.

DIO wiring procedure

- Step 1:** Loosen the screws on the COM 2 terminal. Pinch the tabs on the sides of the COM 2 connector enclosure and pull it at the same time to remove it.
- Step 2:** Loosen the swivel nut and pull out the sealing plugs. Keep them still in the cable support sleeve if you choose not to connect the cable.
- Step 3:** Prepare two four-core signal cable. Trim the excess one core wire. The cut core wire should be insulated. Thread the cables through the swivel nut, cable support sleeve, and connector enclosure in sequence.

- Step 4:** Strip approx.6 mm of the cable insulation. Insert the conductors into the 7-pin terminal block (part N) and tighten the terminal screws (torque: 1.5 N-m.). Ensure that the conductors are firmly seated in the terminal.

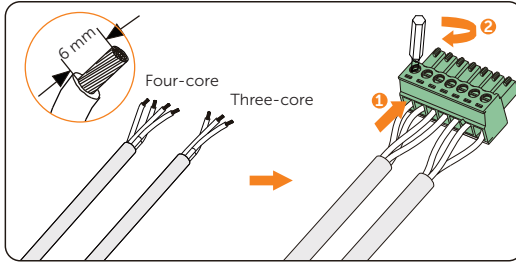

Figure 8-61 Connecting to 7-pin terminal block

- Step 5:** Connect the assembled communication cable into the COM 2 terminal. Lightly pull the cable to confirm tight insertion and then install the connector back.

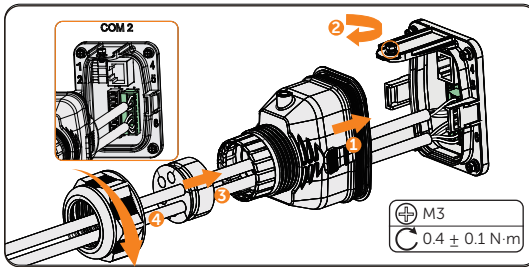

Figure 8-62 Connecting to the inverter

8.8 Monitoring Connection

The inverter provides a DONGLE terminal, which can transmit data of the inverter to the monitoring website via WiFi+LAN dongle. The WiFi+LAN dongle is equipped with 2 kinds of communication modes (Wi-Fi mode or LAN mode). Users can choose based on actual needs. (If needed, purchase products from us.)

Monitoring connection diagram

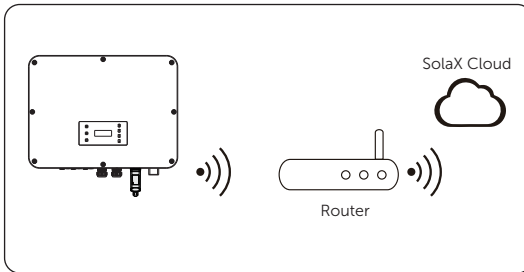

Figure 8-63 Wi-Fi mode connection diagram

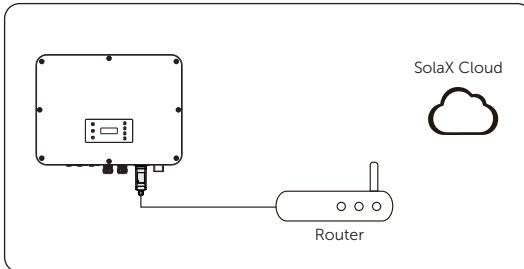

Figure 8-64 LAN mode connection diagram

Monitoring wiring procedure

Wi-Fi mode:

- a. Assemble the dongle;

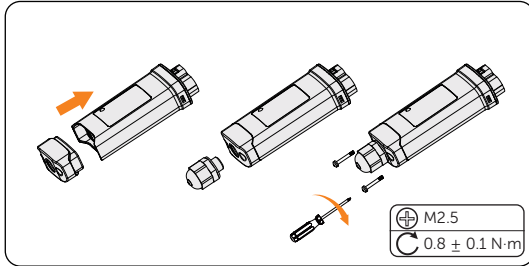

Figure 8-65 Assembling the dongle

- b. Plug the dongle to the inverter.

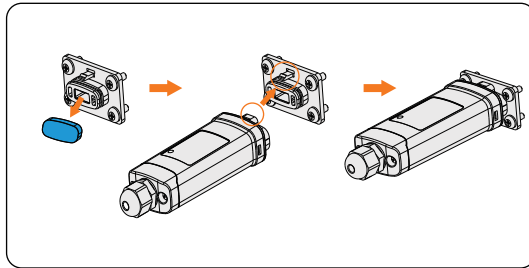

Figure 8-66 Wi-Fi connection procedure

CAUTION!

- The buckles on the inverter and dongle must be on the same side. Otherwise, the dongle may be damaged.

NOTICE!

- The distance between the router and the inverter must be no more than 100 meters. If there are walls in between, the distance must be no more than 20 meters.
- For locations where Wi-Fi signals are weak, install a Wi-Fi signal booster.

NOTICE!

- For details on Wi-Fi configuration, see *Pocket WiFi + LAN Installation Manual*. You can configure Wi-Fi only after the inverter is powered on.

LAN mode:

- a. Disassemble the waterproof connector into components 1, 2, 3 and 4; Component 1 is not used. Keep it in a safe place.

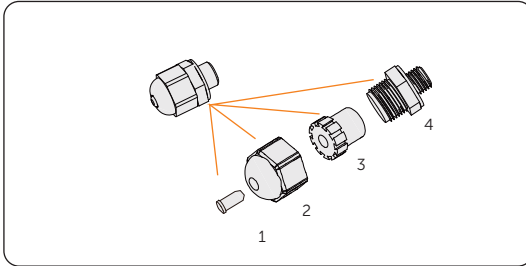

Figure 8-67 Disassembling the waterproof connector

- b. Assemble the dongle.

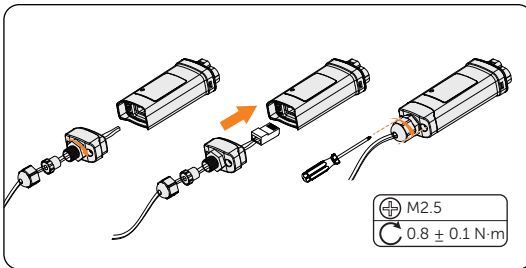

Figure 8-68 Assembling the dongle

- c. Plug the dongle to the inverter

9 System Commissioning

9.1 Checking before Power-on

No.	Item	Checking details
1	Installation	The inverter is installed correctly and securely. The battery is installed correctly and securely. Other device (if any) is installed correctly and securely.
2	Wiring	All DC, AC cables and communication cables are connected correctly and securely; The meter/CT is connected correctly and securely. The ground cable is connected correctly and securely;
3	Breaker	All the DC breakers and AC breakers are OFF;
4	Connector	The external AC and DC connectors are connected; The connectors on the Grid and EPS terminal are connected correctly and securely.
5	Unused terminal	Unused terminals and ports are locked by waterproof caps.
6	Screw	All the screws are tightened.

9.2 Powering on the System

Step 1: Turn on the DC switch and check the LCD screen.

- » If the LCD screen is not on, turn off the DC switch and check whether the PV polarity is connected correctly.
- » If the error of any channel of PV is displayed on LCD, turn off the DC switch and check the corresponding channel of PV connection.

Step 2: Switch on the AC breaker and wait for the inverter power on.

- » During initial power-up, if Meter/CT is connected, automatic check will be enabled:

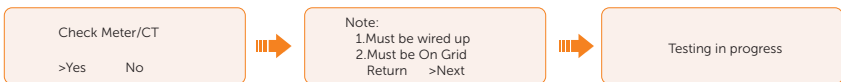

- » Awaiting the display of the check results. Please refer to "[12.3 Meter/CT Fault](#)" for the error code.

Successful Checking
>Yes(OS)

Meter/CT Fault
0
>Retest Skip

- Step 3:** Switch on the battery or the breaker, button, DC switch of the battery (see documentation of the battery manufacturer).
- Step 4:** Check the LCD screen and perform **Forced Discharge** and **Forced Charge** through the setting path **Menu>Mode Select >Manual** to verify if the charging and discharging of battery is normal.

9.3 Operation of lockable DC Switch

This series of inverters are provided with two kinds of DC switches: unlockable DC switch (optional; without lock) and lockable DC switch (standard; with lock).

For lockable DC switch:

The lockable DC switch includes 3 states: ON, OFF, and OFF+Lock. The DC switch is in the OFF state by default.

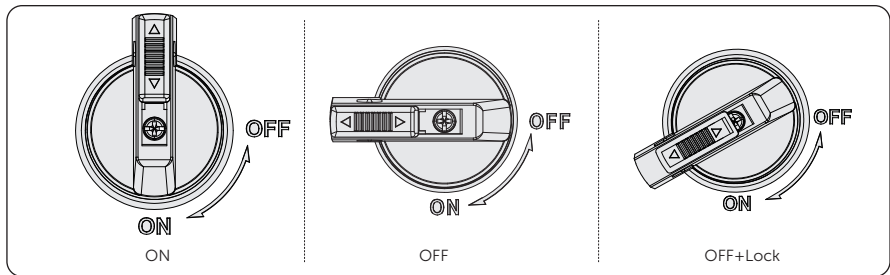

Turn on the DC switch
Turn on the DC switch from OFF state to ON state.

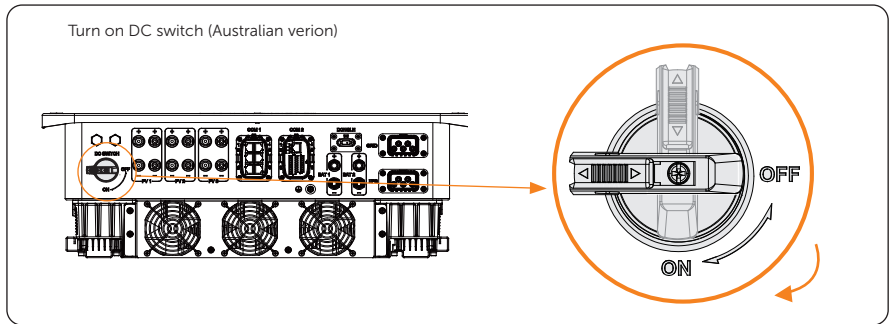

Turn off the DC switch
Rotate the DC switch from ON state to OFF state.

Turn off DC switch (Australian version)

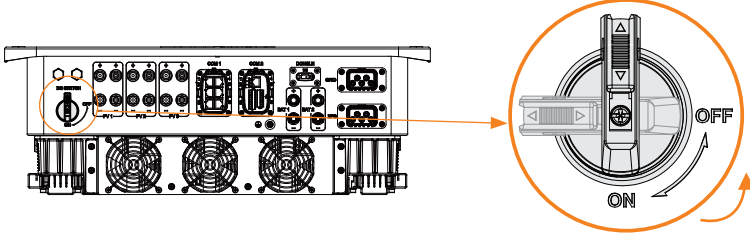

Lock the DC switch

- Rotate the DC switch to OFF state, then rotate the DC switch to the left side;
- Push the position indicated by the arrow upward (as shown in the diagram below).
- (Optional) After pushing the position upward, choose to lock the DC switch with a lock.

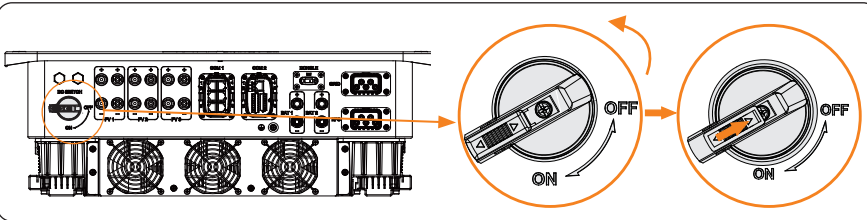

Unlock the DC switch

- Remove the lock. (If any);
- Push the position indicated by the arrow down (as shown in the diagram below);
- Wait for it to return to OFF state.

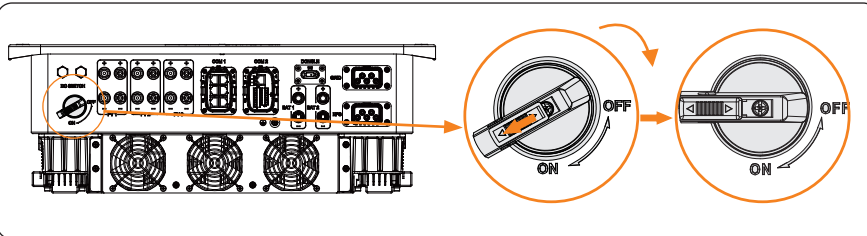

10 Operation on LCD

10.1 Introduction of Control Panel

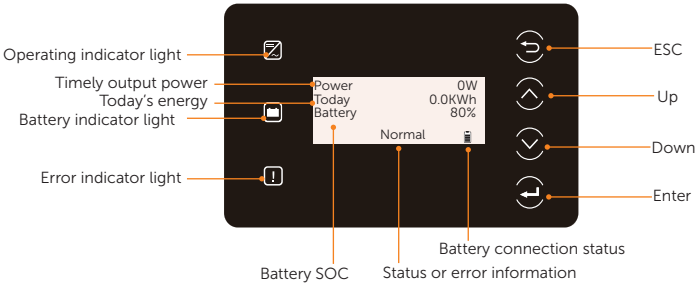

Figure 10-1 Control Panel

- In a normal state, the "Power", "Today" and "Battery" information will be displayed. You can press the keys to switch information.
- In an error state, the fault message and error code will be displayed, please refer to "12.2 Troubleshooting" for corresponding solutions.

Table 10-1 Definition of indicators















LED indicator	Status		Definition
 Operating		Solid blue	The inverter is in a normal state.
		Blue blinking	The inverter is in a waiting or checking state.
 Error		Solid red	The inverter is in a fault state.
	 Battery		Solid green
		Green blinking	Both of the batteries are in an idle state.
 		Solid display	One of the batteries is connected normally at least.
		Blinking	Both of the batteries are disconnected.

Table 10-2 Definition of keys

Key	Definition
 ESC key	Exit from the current interface or function
 Up key	Move the cursor to the upper part or increase the value
 Down key	Move the cursor to the lower part or decrease the value
 Enter key	Confirm the selection

10.2 Introduction of Menu Interface

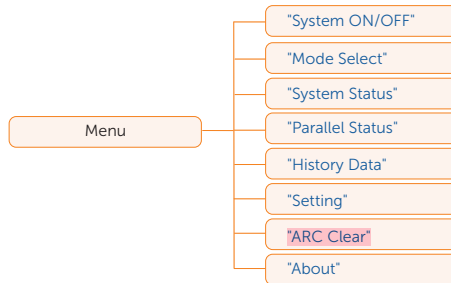

There are eight submenus in the menu that can be selected for relevant setting operations.

- **System ON/OFF:** Switch on and off the inverter.
- **Mode Select:** Select the working mode of the inverter, including **Self Use, Feed-in Priority, Backup Mode, Manual, Peaking Shaving** and **TOU**.

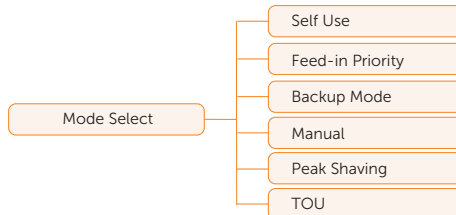

- **System Status:** Display the real-time value of PV, battery, etc. Including **PV1, PV2, PV3, Battery 1, Battery 2, On-grid, EPS** and **Meter/CT**.

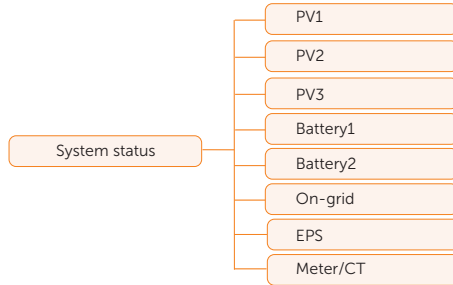

- **Parallel Status:** Display all the status data from master inverter when the inverters are parallel-connected.
- **History Data:** Display the history data of **On-grid, EPS, E_FEEDIN, E_USERDEF** and **Error Log**.

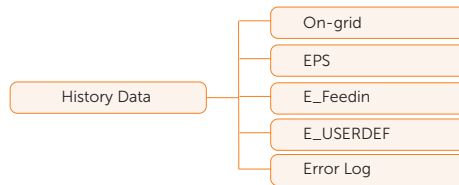

- **ARC Clear:** When it is disabled by default, the inverter will automatically clear the arc fault in five minutes for up to four consecutive times. If the arc fault happened the fifth time, manual clear is needed. For manual clear, select **Trigger** in **Arc Clear**, the inverter will clear the arc fault immediately and restart the system. Other **Arc Enable** and **Arc Self Check** please refer to "**ArcCheck**".

```

=====ARC Clear=====
ARC Clear:
> Disabled <
  
```

- **Setting:** Set the parameters of inverter, including **User Setting** and **Advance Setting**.

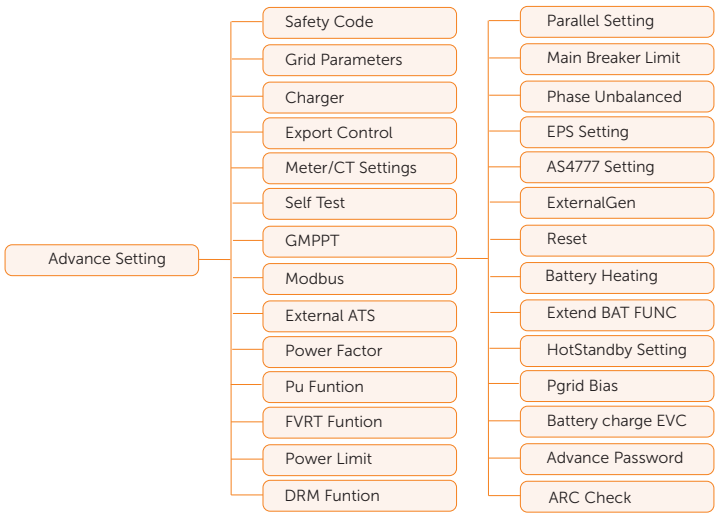
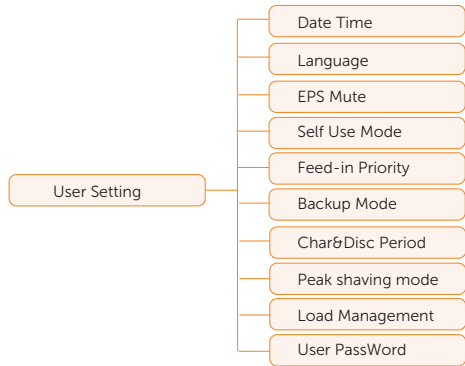

- **About:** Display the information about **Inverter**, **Battery 1**, **Battery 2** and **Internal code**.

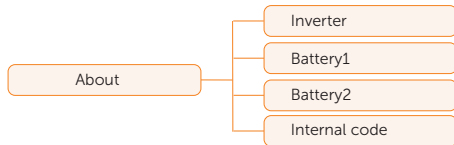

10.3 System ON/OFF

Setting path: **Menu>System ON/OFF**

Select **ON** or **OFF** to switch on and off the inverter. The interface is displayed **ON** by default. When you select **OFF**, the inverter stops running.

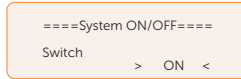

10.4 Mode Select

Selecting path: **Menu>Mode Select**

Here you can only select the working mode. Seven working modes are available for you to choose in on-grid status, i.e Self-use mode, Feedin Priority, Backup, Peak shaving, TOU and Manual. You can choose the working modes according to your lifestyle and environment. Please refer to "2.6 Working mode" for introduction of the modes and "10.7.1 User Setting" for specific setting of each mode.

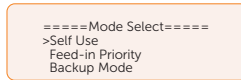

Setting TOU mode

TOU can only be set in SolaX Cloud App. Aftering setting the TOU in the App, the selected TOU mode will be displayed in TOU interface on the LCD.

- » **Min SOC:** The minimum SOC of the system.
- » **Min SOC:** Default: 10%



- » **Self-use:** Same working logic with "Self-use Mode", but it is not limited by the charging and discharging time slots. The priority of PV: Loads > Battery > Grid.
- » **Min SOC:** Default: 10%



- » **Battery off:** The battery neither charges nor discharges. The power of PV will supply to loads or the grid. Only when the battery SOC is lower than the system (TOU) Min SOC, the battery can be charged.

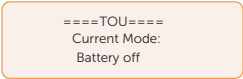

» **Peak shaving:** The working logic is that when the power consumption from the grid exceeds the set PeakLimit value, the battery is allowed to discharge power. The excess power beyond the limit is provided by the combination of photovoltaic and battery to ensure that the maximum power purchased from the grid does not exceed the set limit.

» **Peaklimits:** Default: 1000 W

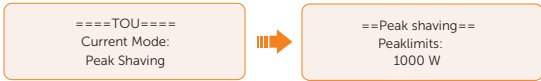

» **Charging:** The power of PV will charge the battery as much as possible to the set SOC of Charge BAT to (%). You can set whether to Charge from grid. The default value of Charge BAT to (%) is 100%. When the battery reaches the set SOC, the surplus power will perform "Self-use Mode" or supply to the grid (based on the system setup), at this point, Charge from grid is not allowed.

» **Charge from grid:** Default: Disable

» **Charge BAT to:** Default: 100%

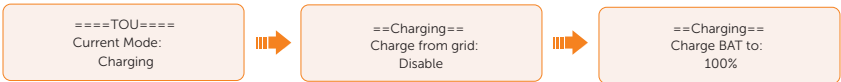

» **Discharging:** If allowed by the battery, the system outputs a specified power from the grid based on the set output percentage, controlling the power at the AC port. You need to set the RatePower (%) through Web or App when choosing Discharging mode. When the battery Discharge to (%) reaches the set SOC, the inverter performs "Self-use Mode".

» **Rate of AC Power:** Default: 100%

» **Discharge to:** Default: 10%

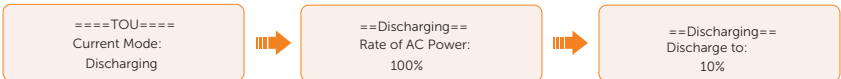

10.5 System Status

Displaying path: **Menu>System Status**

After entering into the **System Status** interface, the status of PV, Battery, On-grid, EPS, Meter/CT will be displayed on the LCD as follows:

- PV status: You can see information of **PV1**, **PV2** and **PV3**. Information contains input voltage, current and power of each PV. For X3-ULT-15K, 19.9K and 20K inverter, the value in PV3 is 0.



- Battery status: There will be information of **Battery1** and **Battery2** displayed here. It shows the status of each battery terminal, including the voltage, current, power, SOC, cell temperature and BMS connection status. Positive value with power means charging; negative value means discharging.

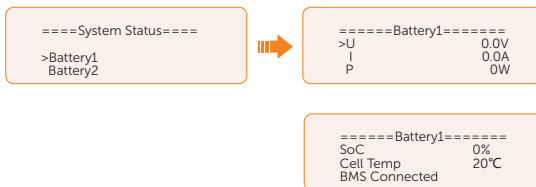

- On-grid status: Information contains the voltage, current, frequency, and output power of Grid terminal. The "A", "B" and "C" in **On-grid A**, **On-grid B** and **On-grid C** refers to L1, L2 and L3 respectively. The figure below will take **On-grid A** as an example. Positive value with power means power output; negative value means power input.

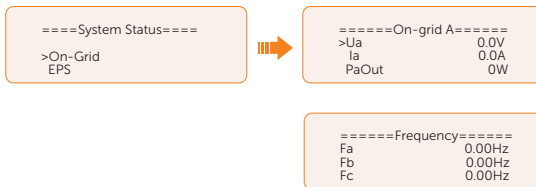

- EPS status: Information contains apparent power, voltage, current, active power and frequency of **EPS** terminal when it is disconnected from the grid. The "A", "B" and "C" in EPS A, EPS B and EPS C refers to L1, L2 and L3 respectively. The figure below will take EPS A as an example.

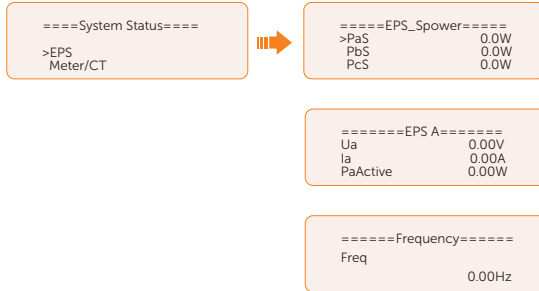

- Meter/CT status: Information contains feed-in power of L1, L2 and L3 detected by the connected meter or CT. Positive represents feeding electricity to the grid, negative represents drawing electricity from the grid (buying electricity).

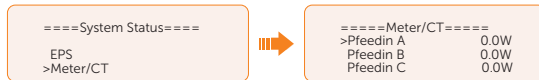

10.6 History Data

Displaying path: **Menu>History Data**

After entering into the History Data interface, the status of **On-grid**, **EPS**, **E_Feedin**, **E_USERDEF**, **Error Log** will be displayed on the LCD as follows:

- **On-grid**: A record of the output and input electric energy of inverter from grid today and the total. (through Grid terminal)
 - » **Output Today**: Output electric energy of inverter today.
 - » **Output Total**: Total output electric energy since the inverter activated for the first time.
 - » **Input Today**: Input electric energy of inverter today.
 - » **Input Total**: Total input electric energy since the inverter activated for the first time.

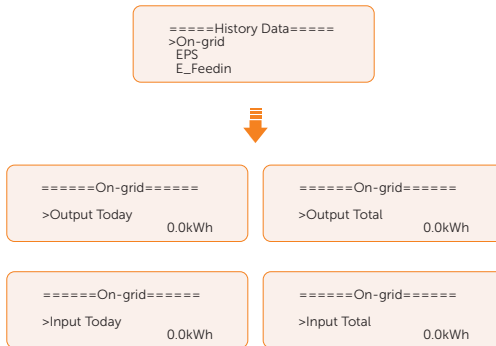

- **EPS**: A record of the output electric energy of the inverter today and the total when it is disconnected from grid. (through **EPS** terminal)

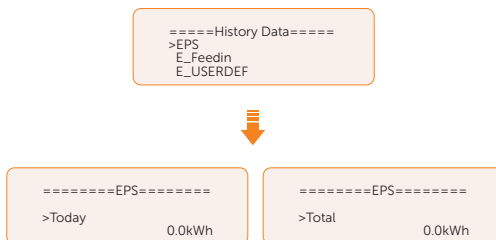

- **E_Feedin**: The total electricity fed into or taken from the grid since the inverter activated for the first time and on that day. (detected by Meter/CT)
 - » **Feedin Today**: Electricity sold to grid today.
 - » **Feedin Total**: Total electricity sold to grid since the inverter activated for the first time.

- » **Consume Today:** Electricity bought from grid today.
- » **Consume Total:** Total electricity bought from grid since the inverter activated for the first time.

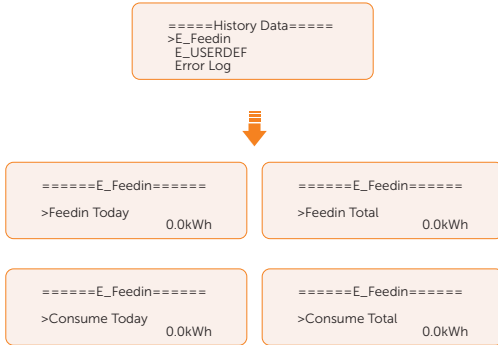

- **E_USERDEF:** The electricity of the connected on-grid inverter today and the total.(detected by Meter 2) This function is only available when the meter 2 is connected.

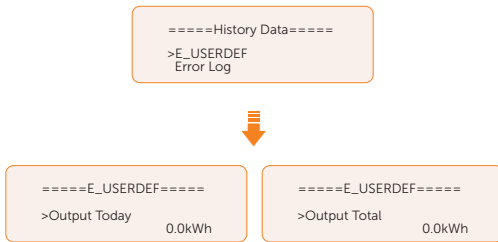

- **Error Log:** Display the recent six error messages. Information contains date and time error happened, error code and error description.



10.7 Setting

Settings includes User Settings and Advanced Settings.

10.7.1 User Setting

Setting path: **Menu>Setting ("0 0 0 0")>User Setting**

NOTICE!

The default password for **User Setting** is "0 0 0 0".

Setting Date & Time

You can set the current date and time of the installation site.

The display format is "2023-06-16 14:00", in which the first four numbers represent the year (e.g. 2000~2099); the fifth and sixth numbers represent the month (e.g. 01~12); the seventh and the eighth numbers represent the date (e.g. 01~31). The remaining numbers represent the time.



Setting Language

This inverter provides multiple languages for customers to choose, such as English, Deutsch, francais, Polskie, Espanol, Português. The default language is English.



Setting EPS Mute

When the inverter is running in EPS Mode, you can choose whether the buzzer is turned on or not .

- Select **Yes**, the buzzer mutes. This function is turned off by default.
- Select **NO**, the buzzer will sound once every 4 seconds if the battery SOC is > EPS min. SOC. When the battery SOC is equal to EPS min SOC, the buzzer will sound with higher frequency at every 400 ms.



Setting Self Use Mode

Please refer to "2.7.1 Self-use Mode" for working logic of this mode.

- **Min SOC:** Default: 10%; range: 10%~100%
 - » The minimum SOC of the battery. The battery will not discharge power when the SOC of the battery reaches this value.



- **Charge from grid:**
 - » You can set whether to draw electricity from the grid to charge the battery during the forced charging period. When **Charge from grid** is set to **Enable**, the utility power is allowed to charge the battery; when it is set to **Disable**, the utility power is not allowed to charge the battery.

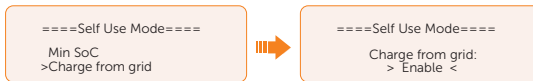

- **Charge battery to:** Default: 30%; range: 10%~100%
 - » Set the SOC target value for charging the battery from grid during the forced charging period (applicable only when the **Charge from grid** is enabled).
 - » You can set your own target value, i.e. during the forced charging period, the inverter will use both PV & GRID energy to charge the battery SOC to the target SOC value+5%, after the battery SOC meets the target value, if the PV energy is still sufficient (enough for load and there is excess power), the inverter will continue to use PV energy to charge the battery.

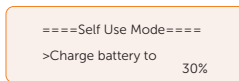

Setting Feed-in Priority

Please refer to "2.7.2 Feed-in Priority" for working logic of this mode.

- **Min SOC:** Default: 10%; range: 10%~100%
 - » The minimum SOC of the battery. The battery will not discharge power when the SOC of the battery reaches this value.



- **Charge battery to:** Default: 50%; range: 10%~100%

- » Set the amount of SOC to charge the battery from grid (applicable only when the **Charge from grid** is enabled).
- » You can set your own target value, i.e. during the forced charging period, the inverter will use both PV & GRID energy to charge the battery SOC to the target SOC value+5%, after the battery SOC meets the target value, if the PV energy is still sufficient, the surplus power will be fed into the grid.

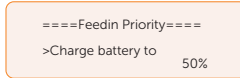

Setting Backup Priority

Please refer to "2.7.3 Backup Mode" for working logic of this mode.

- **Min SOC:** Default: 30%; range: 30%~100%
 - » The minimum SOC of the battery The battery will not discharge power when the SOC of the battery reaches this value.

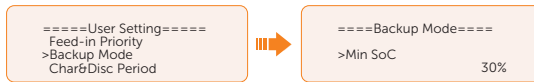

- **Charge battery to:** Default: 50%; range: 30%~100%
 - » In this mode, the charge from grid function is turned on by default, and customers can set the target value by themselves, that is, during the forced charging period, the inverter will cooperate with PV&GRID to charge the battery to the target value. if the PV energy is still sufficient (enough for load and there is excess power), the inverter will continue to use PV energy to charge the battery.

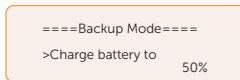

Setting Char&Disc Period

Here you can set the **Forced Charge Perid** and **Allowed Disc Period**. If two charging and discharging periods are needed, enable the **Function Control** to activate the **Char&DischargPeriod2**.

- **Char&Disc Period:** You can set the charge and discharge time according to your own needs. The default time axis of the system is 24h.
 - » **Forced Charge Period Start Time:** Time to start charging; default: 00:00; range: 00:00~23:59
 - » **Forced Charge Period End Time:** Time to stop charging; default: 00:00; range: 00:00~23:59

- » **Allowed Disc Period Start Time:** Time allows to start discharging (The charging or discharging of the battery depends on the work mode.) default: 00:00; range: 00:00~23:59
- » **Allowed Disc Period End Time:** Time to stop discharging; default: 23:59; range: 00:00~23:59

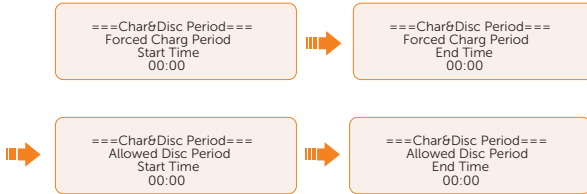

- **Char&Disc Period2:** The second time axis is closed by default, If two charging and discharging periods are needed, turn on the charging and discharging period 2. This period will hold the same setting logic as **Char&Disc Period**.

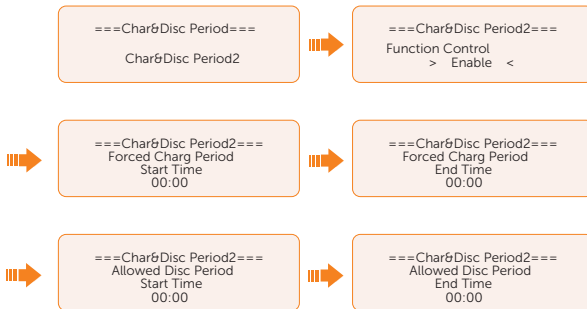

NOTICE!

- The charging and discharging period is only applicable for self-use mode, feed-in priority and backup mode.
- In the period not set as forced charging period and allowed discharging period, the battery can be charged but can not discharge power.
- In the period simultaneously set as forced charging period and allowed discharging period, the battery will be charged forcibly.

Setting Peak shaving mode

Peak shaving mode is suitable for regulating electricity usage during peak periods. It involves utilizing stored energy from non-peak periods to supply electricity during peak periods. Please refer to "2.7.4 Peak Shaving Mode" for working logic of this mode.

- **DisChgPeriod1:** To set **ShavingStartTime**, **ShavingEndTime** and **PeakLimits**. **DisChgPeriod1** can be regarded as Peak shaving period. This period should be set to cover load peaks. Battery will be discharged to shave load peak until battery

SOC drops to Min SOC (10% by default).

- » **PeakLimits1:** Default:0 W, range: 0-60000 W

Once the consumption (grid side) reaches this value, the inverter will start shaving to keep the consumption lower than this value.

- » **ShavingStartTime:** Default: 7:00

The battery starts discharging to shave consumption from the set time.

- » **ShavingEndTime:** Default: 15:00

The battery stops discharging at the set time.

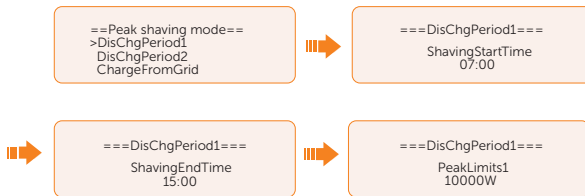

- **DisChgPeriod2:** Same working logic with DisChgPeriod1

- » **PeakLimits2:** Default:0 W, range: 0-60000 W

- » **ShavingStartTime:** Default: 19:00

The battery starts discharging to shave consumption from the set time.

- » **ShavingEndTime:** Default: 23:00

The battery stops discharging at the set time.

- **ChargeFromGrid:** It can be used in specific time period. This period allows inverter to take energy from grid to charge battery in order to have enough backup for peak shaving. Please note that this period starts from ShavingEndTime2, end until ShavingStartTime1.

- » **Enable:** Activate the function of **ChargeFromGrid** to allow the inverter taking grid energy to charge battery. The **ChargePowerLimits** and **MAX_SOC** will be displayed only when **ChargeFromGrid** is enabled.

- » **ChargePowerLimits:** Default: 1000 W; range: 0-60000 W

Settable target power taken from grid. Inverter will use this target power taken from grid to charge battery.

- » **MAX_SOC:** Default: 50%; range: 10%-100%

Inverter will take grid energy to charge battery until battery SOC reaches this value.

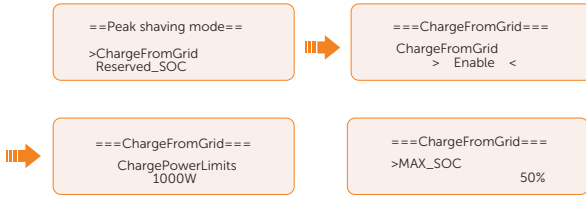

- **Reserved_SOC:** Default: 50%; range: 10%-100%
 - » It can be used in specific time period. In this period, inverter does not allow taking grid energy to charge battery, PV is the only way to charge battery and PV will charge the battery first. Inverter will not supply power to loads until battery SOC higher than this value in order to save enough energy for later shaving period.

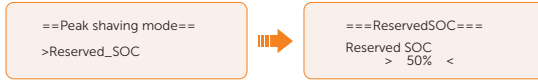

Setting Load Management

To use the heat pump function, you need to set the relevant parameters on LCD screen. This is function is applicable for the first generation of SolaX Adapter Box.

- a. Enter the **Load Management** interface through the path: **Menu>Setting>User Setting>Load Management**
- b. Set the **Load Management** mode. Overall three heat pump operation modes are available for you to choose:

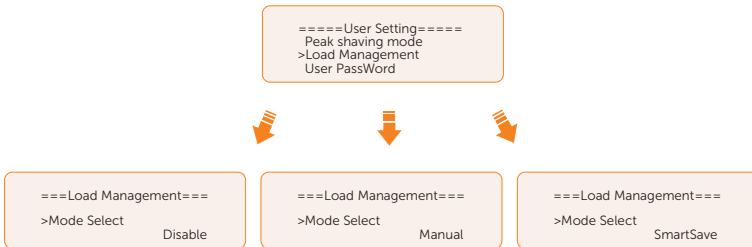

- » **Mode 1 Disable:** The Adapter Box function is disabled under this operation mode.
- » **Mode 2 Manual:** In this operating mode, you can change the Adapter Box from on to off, or from off to on through settings on the inverter or through SolaX App.
- » **Mode 3 SmartSave:** In this operating mode, users can set a series of parameters on the SolaX inverter to intelligently control how and when the

heat pump works for them. (see Step C)heat pump works for them. (see Step C)

- c. Set the parameters for mode **SmartSave**. In this mode, you can set **Thresholds on Feedin power**, **Thresholds off Consumption**, **Thresholds off Battery SOC**, **Minimum duration per on-signal**, **Minimum duration per day** and **Schedule** in accordance with your actual needs.

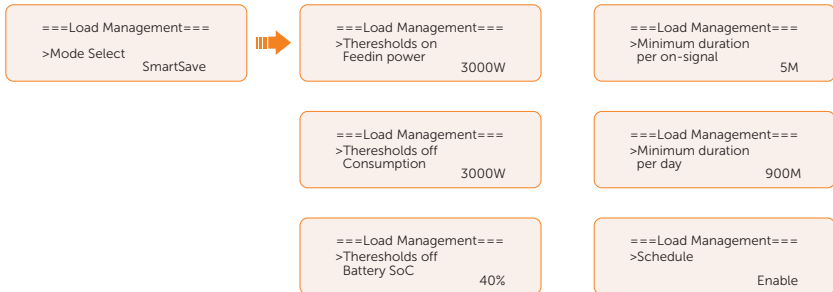

- Setting thresholds on/off
 - » **Thresholds on Feedin power:** Once the feed-in power is greater than or equal to the set value, the Adapter Box will turn on and the heat pump will heat the water up to a higher temperature.
 - » **Thresholds off Consumption:** Once the power consumption (from the grid) is greater than or equal to the set value, the Adapter Box will be turned off, SolaX system stops providing electricity to heat pump.
 - » **Thresholds off Battery SOC:** Once the battery SOC drops to the set value, the Adapter Box will turn off, SolaX system stops providing electricity to heat pump.
- Setting minimum / maximum duration
 - » **Minimum duration per on-signal:** Minimum working hours, heat pump will work at least the time set here every time been activated. High priority than other power threshold settings.
 - » **Maximum duration per day:** Maximum working hour limitation per day. High priority than other power threshold settings.
- Setting schedule
 - » **Schedule:** Set the heat pump working periods flexibly (heat pump on and off periods). High priority than other power threshold settings. Two work periods can be set.

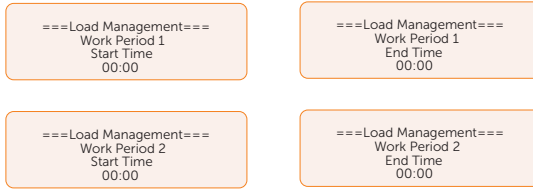

» Mode Priority: **Minimum/Maximum duration > Schedule >Thresholds on/off**

Setting User Password

The default password is "0 0 0 0". You can reset the password here.

10.7.2 Advanced Setting

Setting path: **Menu>Setting>Advance Setting**

NOTICE!

- All the adjustable parameters including safety code, grid parameter, export control, etc. can be modified under the permissions of installer password. Unauthorized use of the installer password by unauthorized persons can lead to incorrect parameters being inputted, resulting in power generation loss or violation of local regulation. Get the installer password from the dealer and never open the password to unauthorized person.

Setting Safety Code

NOTICE!

- The inverter cannot be connected to the grid before the safety code is correctly set. If there is any doubt about your safety code where the inverter installed, please consult your dealer or SolaX service for details.
- The setup will vary from different safety codes.

Here you can set safety code according to different countries and grid-tied standards. In addition, the inverter has an **User Defined** option which allows you to customize relevant parameters with a wider range.

There are several standards to choose from, please refer to the LCD screen on the inverter. (May be changed or added without notice)

Table 10-3 Safety code

Safety code	Country
TOR	Austria

Safety code	Country
G99	United Kingdom
TR	Denmark
EN50549-EE	Estonia
EN50549-SE	Sweden
AS 4777.2	Australia
CEI0-21	Italy
C10/26	Belgium
G100 NI	Northern Ireland
VDE4105	Germany
PEA	Thailand

For Australia, select Australia Region A / B / C in compliance with AS/NZS 4777.2. Only after the safety code setting is completed, some designated parameters in the inverter system will take effect according to the corresponding safety regulations.

Table 10-4 Region settings

Region	Australia A	Australia B	Australia C	New Zealand	
Standard Code Name	AS4777_2020_A	AS4777_2020_B	AS4777_2020_C	New Zealand	Setting Range
OV-G-V	265 V	265 V	265 V	265 V	230-300 V
OV-GV1-T	1.5 s	1.5 s	1.5 s	1.5 s	
OV-G-V2	275 V	275 V	275 V	275 V	230-300 V
OV-GV2-T	0.1 s	0.1 s	0.1 s	0.1 s	
UN-G-V1	180 V	180 V	180 V	180 V	40-230 V
UNGV1-T	10 s	10 s	10 s	10 s	
UN-G-V2	70 V	70 V	70 V	70 V	40-230 V
UNGV2-T	1.5 s	1.5 s	1.5 s	1.5 s	
OV-G-F1	52 Hz	52 Hz	55 Hz	55 Hz	50-55 Hz
OVGF1-T	0.1 s	0.1 s	0.1 s	0.1 s	
OV-G-F2	52 Hz	52 Hz	55 Hz	55 Hz	50-55 Hz
OVGF2-T	0.1 s	0.1 s	0.1 s	0.1 s	

Region	Australia A	Australia B	Australia C	New Zealand	
Standard Code Name	AS4777_2020_A	AS4777_2020_B	AS4777_2020_C	New Zealand	Setting Range
UN-G-F1	47 Hz	47 Hz	45 Hz	45 Hz	40-50 Hz
UNGF1-T	1.5 s	1.5 s	5 s	1.5 s	
UN-G-F2	47 Hz	47 Hz	45 Hz	45 Hz	45-50 Hz
UNGF2-T	1.5 s	1.5 s	5 s	1.5 s	
Startup-T	60 s	60 s	60 s	60 s	15-1000 s
Restore-T	60 s	60 s	60 s	60 s	15-600 s
Recover-VH	253 V	253 V	253 V	253 V	
Recover-VL	205 V	205 V	205 V	198 V	
Recover-FH	50.15 Hz	50.15 Hz	50.15 Hz	50.15 Hz	
Recover-FL	47.5 Hz	47.5 Hz	47.5 Hz	47.5 Hz	
Start-VH	253 V	253 V	253 V	253 V	
Start-VL	205 V	205 V	205 V	198 V	
Start-FH	50.15 Hz	50.15 Hz	50.15 Hz	50.15 Hz	
Start-FL	47.5 Hz	47.5 Hz	47.5 Hz	47.5 Hz	

Setting Grid parameters

The default value is the specified value under the current safety regulations. The contents will be displayed according to the requirements of local laws and regulations. Please refer to the actual contents displayed on the LCD screen on the inverter.

```

====Grid Parameters====
>Overvoltage
Undervoltage
OverFreq_L1
    
```

Setting Charger

The inverter is compatible with lithium-ion battery. You can set the charge & discharge parameters of battery.

- **Max Charge:** Maximum charging current of battery
- **Max Discharge:** Maximum discharging current of battery
- **Charger upper limit:** Default: 60%, range: 10%-100%
 - » The maximum battery SOC when charging.

```

=====Charger=====
>Max Charge
Current:                60.0A
    
```

```

=====Charger=====
>Max DisCharge
Current:                60.0A
    
```

```

=====Charger=====
>Charger upper limit
                        100%
    
```

Setting Export Control

This function allows the inverter to control power output to the grid. The user value set must be less than the maximum value. If the user does not want to supply power to the grid, set **User Value** to "0".

```

=====Export Control=====
>Soft Limit value
                        30000W
    
```

NOTICE!

- Under Safety Code AS4777, **Export Control** is in the path of **Advance Setting**> **AS4777 Setting**. You can set the **Soft Limit** and **Hard Limit** of **Export Control** to control the power output to grid. Please refer to section AS4777 Setting for details.

Meter/CT Setting

CT or electricity meter is needed to connect with the inverter. Meter is set by default.

NOTICE!

- If the user has other power generation equipment (such as inverter) at home and wants to monitor both, the inverter provides Meter 2 communication function to monitor the power generation equipment.

- Select and enter the **Meter/CT Setting** according the setting path.
- Set the the address and direction of Meter/CT:
 - » Case 1: Only CT is connected for the series inverter. No power generation equipment in the whole system. Please activate the CT selection and choose the supported CT type. You can check the connection status in **Meter/CT Check**.



- » Case 2: Only Meter 1 is connected for the series inverter. No power generation equipment in the whole system. Please activate the meter 1 selection and set the meter address and direction. You can check the

connection status in **Meter/CT Check**.

NOTICE!

- CT and meter 1 can not be used simultaneously.

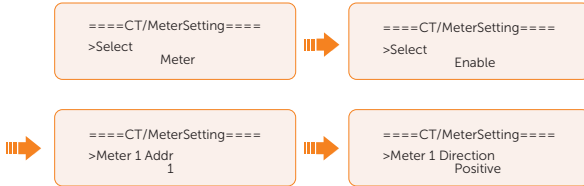

- » Case 3: CT and Meter 2 are connected. (CT for SolaX Hybrid inverter, Meter 2 for another power generation equipment or CT for another power generation equipment, Meter 2 for SolaX Hybrid inverter) For CT setting, please refer to Case 1. For meter 2 setting, please set the address and direction of Meter 2 based on actual connection. You can check the connection status in **Meter/CT Check**.

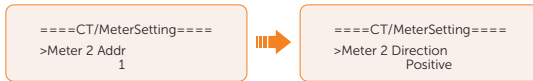

- » Case 4: Meter 1 and Meter 2 are connected. (Meter 1 for SolaX Hybrid inverter, Meter 2 for another power generation equipment or Meter 1 for another power generation equipment, Meter 2 for SolaX Hybrid inverter). Please refer to Case 2 for Meter 1 setting and Case 3 for Meter 2 setting. You can check the connection status in **Meter/CT Check**.

Setting Self Test (only for CEI 0-21)

The self test function allows users to test the following items: **Full Test**, **Ovp(59.S2) test**, **Uvp (s1) test**, **Uvp (27. s2) test**, **Ofp (81> .S1) test**, **Ufp (81 <.S1) test**, **Ufp (81> .S2) test**, **Ufp (81 <.S2) test**, **Ovp(59. s1) test**.

In the **Self Test** interface, the user can select **All Test** or a single test item for testing. All tests take about 6 minutes. And it will display **Success**. For a single test item, it takes about a few seconds or minutes.

Before testing, make sure that the inverter is connected to the grid. Click **Test Report** to view the test results of all items.

====Self Test====

>All Test

Test Report

Ovp (59.S2) test

Setting GMPPT

You can set the shadow tracking speed with four options, which are **Off**, **Low**, **Middle**, and

High. This function is off by default.

- **Off:** Switch off the shadow tracking function.
- **Low:** Scan the shadow every four hours.
- **Middle:** Scan the shadow every three hours.
- **High:** Scan the shadow per hour.

```

=====GMPPT=====
PV1 Control
> Low <
    
```

Setting Modbus

You can set the address and select the baud rate of the external communication protocol for communicating with external equipment.

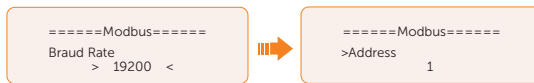

Setting Power Factor

The default value is the specified value under the current safety regulations. The contents will be displayed according to the requirements of local laws and regulations. Please refer to local grid requirements.

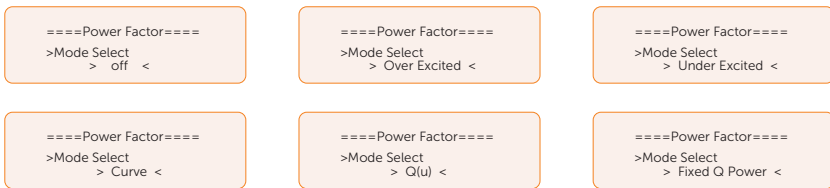

Table 10-5 Items under Power Factor

Off	
Over Excited	PF Value
Under Excited	PF Value

Operation on LCD

Curve	P1 PF
	P2 PF
	P3 PF
	P4 PF
	Power 1
Curve	Power 2
	Power 3
	Power 4
	PflockInPoint
	PflockOutPoint
	3Tua
Q(u)	SetQuPower1
	SetQuPower2
	SetQuPower3
	SetQuPower4
	QuRespondV1
	QuRespondV2
Q(u)	QuRespondV3
	QuRespondV4
	K
	3Tua
	QuDelayTimer
	QuLockEn
Fixed Q Power	Q Power

- Reactive power control, reactive power standard curve $\cos \varphi = f(P)$
 - » For VDE ARN 4105, the curve $\cos \varphi = f(P)$ should refer to curve A. The set default value is shown in curve A.

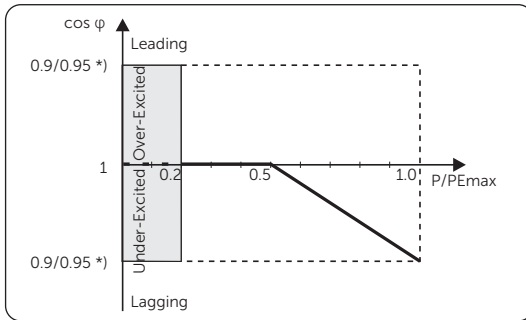

Figure 10-2 Curve A

*) If the grid-connected power of the inverter ≤ 4.6 kW, the Power Factor is 0.95 at 1.0 power; if the grid-connected power of the inverter > 4.6 kW, the Power Factor is 0.90 at 1.0 power.

- » For TOR, the curve $\cos \varphi = f(P)$ should be curve B. The set default value is shown in curve B.

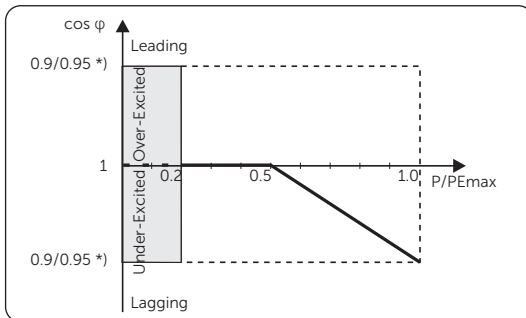

Figure 10-3 Curve B

*) Depend on the required Q capacity

- » For CEI 0-21, the default value of PFLockInPoint is 1.05. When $V_{ac} > 1.05V_n$, $P_{ac} > 0.2 P_n$, curve $\cos \varphi = f(P)$ corresponds to curve C.

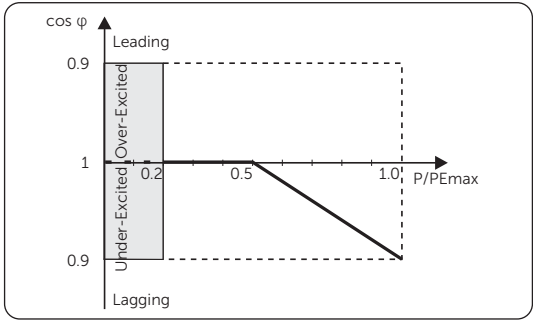

Figure 10-4 Curve C

- Reactive power control, reactive power standard curve $Q = f(V)$

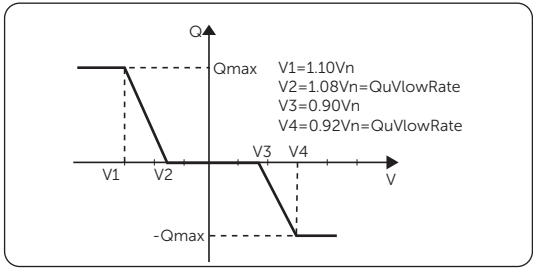

Figure 10-5 Curve $Q = f(V)$

Setting Pu Function

(Applicable to specific countries, please refer to local grid requirements.)

The Pu function is a volt-watt response mode required by certain national standards such as AS/NZS 4777.2. This function can control the active power of the inverter according to the grid voltage. You can set **Response Voltage**, **3Tau**, **PuPower**, **3Tau_Charge** and **Pu Type**.

The items in the **P(u) Function** interface will be adjusted in accordance with the local safety requirements and law regulations, casual modification is prohibited.

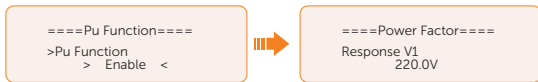

For AS/NZS 4777.2, the curve required for the volt-watt mode can be referred to the below curve.

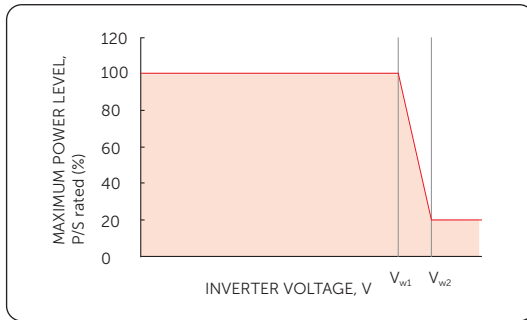
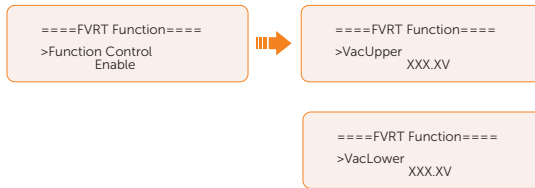

Figure 10-6 Curve for P(u)

Setting PVRT function

PVRT consists of HVRT (High Voltage Ride Through) and LVRT (Low Voltage Ride Through). With PVRT function, the series inverter can ensure continuous operation without disconnecting from the grid within a certain range of voltage sudden rise and drop in a certain time interval.

- **Enable:** Enable the PVRT function
- **VacUpper:** The voltage for high voltage ride through
- **VacLower:** The voltage for low voltage ride through



Setting Power Limit

Here you can set the rated power by percentage.

The percentage of rated output power is used as the actual output power.

Proportion: Default: 1.00; range: 0.00-1.10

(For 30 kW inverter, the proportion can only be set to 0.00-1.00 and for other models of this series inverter, the proportion can be set to 0.00-1.10.)

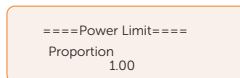

Setting DRM function (Applicable to AS4777)

The DRM Function is a demand response method required by the AS4777 standard and is only applicable to Australia and New Zealand.

The function is enabled by default.

```
====DRM Function====  
>Func Select  
  Enable
```

Setting Main Breaker Limit

Due to power limit, the current of Meter or CT must be abide by the utility's requirements. You can set the corresponding amperage according to the utility's requirements. Failure to set the current may cause a circuit breaker fault of main switchboard, thus affecting the charging and discharging of battery.

The default value is 100 A, range: 10-250 A

```
==Main Breaker Limit==  
>Current  
  100 A
```

Setting Phase Unbalanced

This function controls the distribution of AC output power. **Disable** is the default setting.

- **Enable** mode: Each phase of power will be independently outputted according to the corresponding loads connected with each phase.

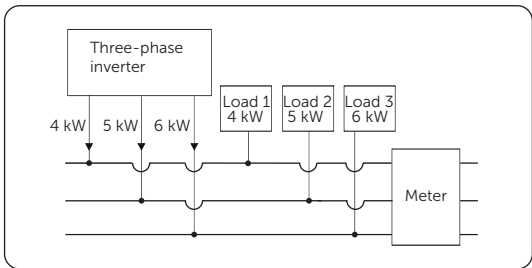

Figure 10-7 Phase Unbalanced enabled

- **Disable** mode: Three-phase power balanced output, with equal power in each phase. The total power output is determined by the total load power of the three phases.

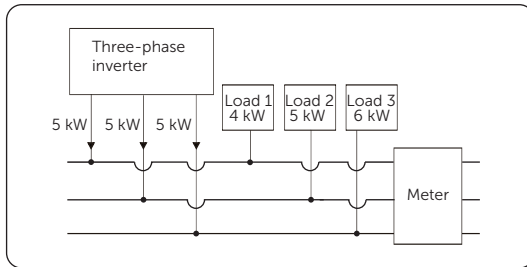
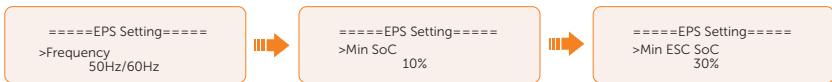

Figure 10-8 Phase Unbalanced disabled

Setting EPS Setting

Select and enter **EPS Setting** interface and set **Frequency**, **Min SOC** and **Min ESC SOC**.

- **Frequency:** Default: 50Hz. Output frequency of EPS
- **Min SOC:** Default: 10%, range: 10%-100%
 - » If the battery SOC is lower than the **Min SOC**, the inverter will prompt **BatPowerLow** and turn off if there is no PV input.
- **Min ESC SOC:** Default: 30%, range: 15%-100%
 - » In EPS mode, the minimum SOC required for re-entry EPS mode after **BatPowerLow** prompted. When the battery SOC reaches the **Min ESC SOC** through charging from PV, the inverter will automatically enter EPS mode from EPS Waiting mode.



- To enable the **Super-Backup** mode and allow only PV without battery to enter EPS. **Disable** is the default setting.

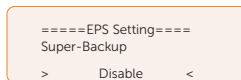

For three-phase inverters, the output power of EPS terminals is restricted to half (50%) of the nominal output power of EPS terminals (with battery) total phase. For more details in the table below.

EPS output (Without battery)	X3-ULT-15KP	X3-ULT-15K	X3-ULT-19.9K	X3-ULT-20K	X3-ULT-20KP	X3-ULT-25K	X3-ULT-30K
Normal output power (W)	7500	7500	9999	10000	10000	12500	15000

Peak apparent power (VA) 130% overload	9750	9750	12999	13000	13000	16250	19500
---	------	------	-------	-------	-------	-------	-------

Setting AS4777 Setting

The function of **AS4777 Setting** is only activated when the **Safety Code** is set to AS4777 and New Zealand, which is only applicable to Australia and New Zealand.

- Select and enter **AS4777 Setting** in **Advance Settings** interface. You will see **Export Control** (for active power output control) and **General Control** (for apparent power output control).

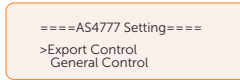

- Set the **Soft Limit** value and **Hard Limit** value for Export Control and General Control. The figure below will take the setup of Export Control as an example.

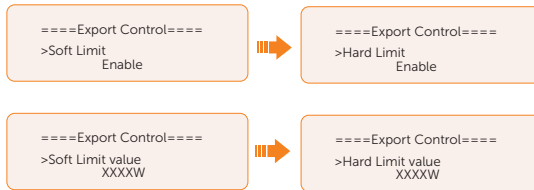

NOTICE!

- **Soft Limit:** Control the output value to grid within the set **Soft Limit Value**.
- **Hard Limit:** If the actual output value reaches the set **Hard Limit Value**, the system will automatically disconnect from grid and prompt error message on the LCD.

Setting ExternalGen

Refer to the "[15.1 Generator Application](#)" for reference.

ArcCheck

The inverter has arc detection function, which detects the arcing of the DC side and cuts the circuit in time to protect the user and the electrical system. The arc module of the series inverter meets the requirements of IEC 63027.

The user can do settings about **ARC Enable** and **ARC Self Check**.

- **ARC Enable:** Select **Enable** in **ARC Enable**, the inverter will report **ARC Fault** when faults are detected. When it is disabled, there won't be any reports even when

faults occurred, and the faults will be cleared simultaneously

```

=====ARC Enable=====
>ARC Enable:
  Disable
    
```

- **ARC Self Check:** Select Enable in **ARC Self Check**, the inverter will self-check whether the arc detection function is working normally and return to **NULL** after the checking process is completed.

```

=====ARC Self Check=====
>ARC Self Check:
  NULL
    
```

NOTICE!

- **ARC Self Check** should be done when the inverter is in normal state and the current is greater than 1.5 A. If an **ARC Fault** is reported and displayed on the inverter if turned back to the main interface, the arc detection function is working normally.

Reset

Here you can reset value of Error Log, Meter/CT, INV Energy, Wifi and restore to the factory set.

- **Reset Error Log**



- **Reset Meter/CT**



- **Reset INV Energy**



- **Reset Wifi**



- **Factory Reset**

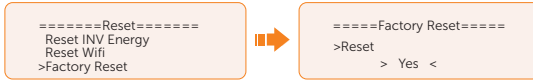

Setting Battery Heating

This function is disabled by default and is only valid when the battery has the heating function. You can enable **Battery Heating** function to make the battery heated. And set the heating period.

- Enable the **Battery Heating** function.

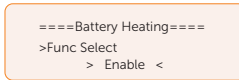

- Set the heating start time and end time for the battery. Two heating periods can be set.

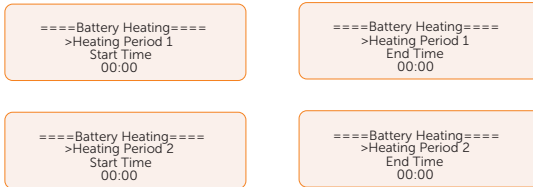

NOTICE!

- If the ambient temperature is extremely low, turning on battery heating will consume a significant amount of electrical energy

Setting Extend BAT FUNC

This function allows for the extension of battery modules, such as adding a new battery module to an existing system. It is only applicable and functional in on-grid mode and cannot be used in EPS mode. In on-grid mode, enabling this function will make the inverter to charge or discharge the battery SOC to approximately 38%. This function will turn to **Disable** automatically after 48 hours this function enabled.

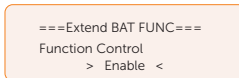

Setting HotStandby Setting

This function is mainly to reduce the energy losses of the system when the power of load

is very low.

- **Enable:** When the power of load is very low and other conditions for entering hot standby are met, the inverter will enter **HotStandby** status to reduce system losses.
- **Disabled:** Even when the power of load is very low and other conditions for entering hot standby are met, the inverter will not enter **HotStandby** status and continue to output power to the load. It is disabled by default.

```

===HotStandby Setting===
Function Control
> Enable <
  
```

Setting Pgrid Bias

This function is disabled by default.

When the inverter has no power output:

- Check the **Meter/CT** value in **Menu>System Status>Meter/CT** when the function is disabled.
- If the **Meter/CT** displayed in **System Status** is negative value, please select **Grid** for **Pgrid Bias** to discharge power to the mains. If the **Meter/CT** displayed in **System Status** is positive value, please select **INV** for **Pgrid Bias** to take power from the mains.

```

=====Pgrid Bias=====
> Grid <
  
```

Setting Internal485

You can communicate with other SolaX equipment, such EV Charger, Datahub, COM485 and AdapterBox G2 through **Internal485**.

- Select and enter **Internal485** interface;
- Select the equipment which needs to be connected and set the corresponding Braud Rate and Address. Take EV Charger as an example, The default baud rate is 9600.

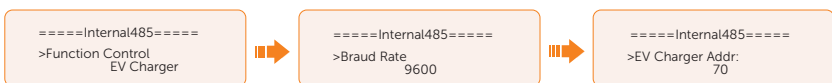

NOTICE!

- When two equipments need to be connected at the same time, the Braud Rate and address of the two equipments shall be set to the same.

- c. Check the connecting status.

```
====Internal485====  
>EV Charger COM STAT  
Connected
```

Battery Charge EVC

You can set **Enable** to allow the battery to discharge energy to EV Charger. When you set to **Disable**, battery discharging energy to EV Charger is not allowed.

```
===Battery charge EVC===  
>Function Control  
Enable
```

Advanced Password

You can reset the advanced password here.

10.8 About

Displaying path: **Menu > About**

Here shows the basic information of the inverter, battery and internal code. Aftering entering into the About interface, you can check those information.

- Inverter
 - » Inverter SN, Register SN, ARM Verion, DSP version, On-grid Runtime, EPS Runtime.
- Battery 1 and Battery 2
 - » BatBrand, Bat_M SN (SN of BMS), Bat_PS1 SN (SN of battery module 1), Bat_PS2 SN (SN of battery module 2), Bat_PS3 SN (SN of battery module 3), Bat_PS4 SN (SN of battery module 4), Battery M Version (software version of BMS) and Battery S version (software version of battery module).
- Internal Code
 - » Internal code of inverter, battery 1 and battery 2.

11 Operation on SolaX Cloud App

11.1 Introduction of SolaX Cloud App

SolaX Cloud provides customers with a platform that can monitor SolaX inverter data and set it remotely. The inverter connects the system through Pocket Wifi, Pocket LAN, Pocket 4G or Ethernet direct connection, and upload the operation data to SolaX Cloud every 5 minutes. You can log in to your user account at any time through a personal computer, IOS or Android device to view real-time monitoring data or historical data, and perform remote settings as needed.

11.2 Downloading and installing App

11.2.1 Downloading and installing App

Select and scan the QR code below to download SolaxCloud APP. You can also find the QR codes at the top left of the login page of www.solaxcloud.com or on the user manual of Pocket series communication module. In addition, you can search with the key word SolaxCloud in Apple Store or Google Play to download it.



Figure 11-1 QR code

Please check the online App guide, Wifi connection guide or Setup tutorial video on the SolaXCloud App for relevant operation.

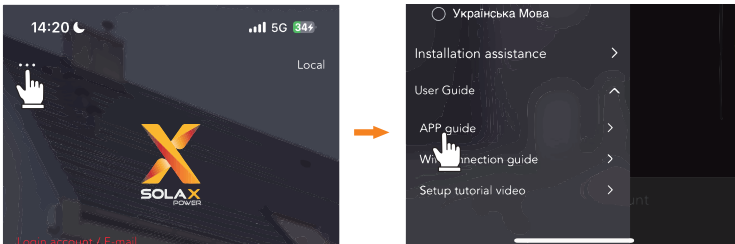

Figure 11-2 App guide on SolaXCloud

NOTICE!

- The screenshots in this chapter correspond to the SolaX Cloud App V4.2.8.

11.3 Operation Guide on SolaXCloud Web

Open a browser and enter www.solaxcloud.com to complete registration, login, add site and other related operations according to the guidelines of user guide.

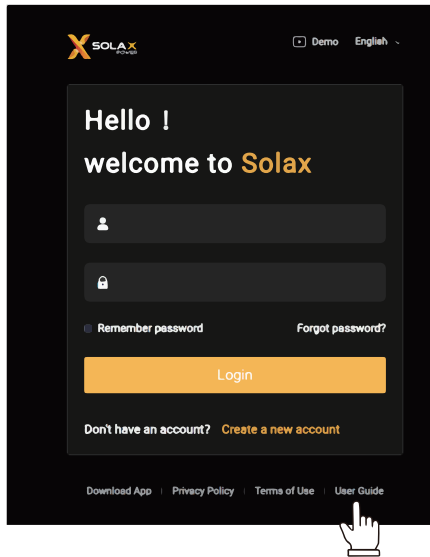

Figure 11-3 User guide on Web

12 Troubleshooting and Maintenance

12.1 Power off

- Turn off the system by **System ON/OFF** on LCD screen.
- Switch off the battery or the load-break switch of the battery (see documentation of the battery manufacturer).
- Turn off the AC switch between the inverter and the power grid.
- Set the DC switch to "OFF".



- After the inverter powers off, there will still be the remaining electricity and heat which may cause electric shocks and body burns. Please wear personal protective equipment (PPE) and begin servicing the inverter five minutes after power off.

12.2 Troubleshooting

This section contains information and procedures for resolving possible problems with the inverter, and provides the troubleshooting tips to identify and solve most problems that may occur. Please check the warning or fault information on the system control panel or on the App and read the suggested solutions below when error occurs. Contact SolaX Customer Service for further assistance. Please be prepared to describe the details of your system installation and provide the model and serial number of the inverter.

Table 12-1 Troubleshooting list

Error Code	Fault	Descriptions and Diagnosis
IE 01	TZ Protect Fault	<p>Overcurrent fault.</p> <ul style="list-style-type: none">Wait for a while to check if it returns to normal.Disconnect PV+ PV- and batteries, reconnect.If the system is in off-grid state, check if the power of EPS loads exceeds the maximum limit of the system or exceeds the current power supply of battery.If the system fails to restore to its normal state, please contact SolaX for help.
IE 02	Grid Lost Fault	<ul style="list-style-type: none">Check the grid connection statusOr contact SolaX for help.

Error Code	Fault	Descriptions and Diagnosis
IE 03	Grid Volt Fault	Power grid voltage overrun <ul style="list-style-type: none">• Wait a moment, if the utility returns to normal, the system will reconnect.• Please check if the grid voltage is within normal range.• Or contact SolaX for help.
IE 04	Grid FreqFault	Grid overfrequency <ul style="list-style-type: none">• Wait a moment, If the utility returns to normal, the system reconnects.• Or contact SolaX for help.
IE 05	PV Volt Fault	PV overvoltage <ul style="list-style-type: none">• Check the output voltage of the PV panel.• Check if the DC switch is OFF.• Or contact SolaX for help.
IE 06	Bus Volt Fault	<ul style="list-style-type: none">• Press the ESC key to restart the inverter.• Check if the PV input open circuit voltage is in the normal range.• Check if the power of half-wave load exceeds the system limit.• Or contact SolaX for help.
IE 07	Bat Volt Fault	Battery voltage fault <ul style="list-style-type: none">• Check if the battery input voltage is within normal range• Or contact SolaX for help.
IE 08	AC10mins Volt	Grid voltage out of range in the last 10 minutes. <ul style="list-style-type: none">• The system will return to normal if the grid returns to normal.• Or contact SolaX for help.
IE 09	DCI OCP Fault	DCI overcurrent protection fault. <ul style="list-style-type: none">• Wait for a while to check if it's back to normal.• Or contact SolaX for help.
IE 10	DCV OVP Fault	DCV EPS(Off-grid) overvoltage protection fault. <ul style="list-style-type: none">• Wait for a while to check if it's back to normal.• Or contact SolaX for help.
IE 11	SW OCP Fault	Software detection of overcurrent Fault. <ul style="list-style-type: none">• Wait for a while to check if it's back to normal.• Shut down photovoltaic, battery and grid connections.• Or contact SolaX for help.

Error Code	Fault	Descriptions and Diagnosis
IE 12	RC OCP Fault	Overcurrent protection fault. <ul style="list-style-type: none"> • Check the impedance of DC input and AC output. • Wait for a while to check if it's back to normal. • Or contact SolaX for help.
IE 13	Isolation Fault	Insulation fault <ul style="list-style-type: none"> • Please check the wire insulation for damage. • Wait for a while to check if it's back to normal. • Or contact SolaX for help.
IE 14	Temp Over Fault	Temperature out of range <ul style="list-style-type: none"> • Check if the ambient temperature exceeds the limit. • Or contact SolaX for help.
IE 15	Bat Con Dir Fault	<ul style="list-style-type: none"> • Battery direction fault • Check if the battery lines are connected in the opposite direction. • Or ask for help from the installer if it can not return to normal.
IE 16	EPS Overload Fault	EPS(Off-grid) overload fault <ul style="list-style-type: none"> • Shutdown the high-power device and press the ESC key to restart the inverter. • Or contact SolaX for help if it can not return to normal.
IE 17	Overload Fault	On-grid mode overload fault <ul style="list-style-type: none"> • Shutdown the high-power device and press the ESC key to restart the inverter. • Or contact SolaX for help if it can not return to normal.
IE 18	BatPowerLow	Bat Power Low <ul style="list-style-type: none"> • Shutdown the high-power device and press the ESC key to restart the inverter. • Please charge the battery to a level higher than the protection capacity or protection voltage.
IE 19	BMS Lost	Battery communication lost <ul style="list-style-type: none"> • Check that the communication cable between the battery and the inverter are properly connected. • Or contact SolaX for help if it can not return to normal.
IE 20	Fan Fault	Fan Fault <ul style="list-style-type: none"> • Check for any foreign matter that may have caused the fan not to function properly. • Or contact SolaX for help if it can not return to normal.

Error Code	Fault	Descriptions and Diagnosis
IE 21	Low TempFault	<p>Low temperature fault.</p> <ul style="list-style-type: none"> • Check if the ambient temperature is too low. • Or contact SolaX for help if it can not return to normal.
IE 25	InterComFault	<p>Inter_Com_Fault</p> <ul style="list-style-type: none"> • Restart the inverter. • Or contact SolaX for help if it can not return to normal.
IE 26	INVR EEPROM	<p>Inverter EEPROM Fault.</p> <ul style="list-style-type: none"> • Shut down photovoltaic, battery and grid, reconnect. • Or contact SolaX for help if it can not return to normal.
IE 27	RCD Fault	<p>Residual Current Device fault</p> <ul style="list-style-type: none"> • Check the impedance of DC input and AC output. • Disconnect PV + PV - and batteries, reconnect. • Or contact SolaX for help if it can not return to normal.
IE 28	Grid Relay Fault	<p>Electrical relay fault</p> <ul style="list-style-type: none"> • Disconnect PV+ PV- grid and batteries and reconnect. • Or contact SolaX for help if it can not return to normal.
IE 29	EPS Relay Fault	<p>EPS relay fault</p> <ul style="list-style-type: none"> • Disconnect PV+ ,PV-, grid and batteries and reconnect. • Or contact SolaX for help if it can not return to normal.
IE 30	PV ConnDirFault	<p>PV direction fault</p> <ul style="list-style-type: none"> • Check if the PV input lines are connected in the opposite direction. • Or contact SolaX for help if it can not return to normal.
IE 31	Battery Relay	<p>Charge relay fault</p> <ul style="list-style-type: none"> • Press the ESC key to restart the inverter. • Or contact SolaX for help if it can not return to normal.
IE 32	Earth Relay	<p>EPS(Off-grid) earth relay fault</p> <ul style="list-style-type: none"> • Press the ESC key to restart the inverter. • Or contact SolaX for help if it can not return to normal.

Error Code	Fault	Descriptions and Diagnosis
IE 33	ParallelFault	<p>Parallel Fault</p> <ul style="list-style-type: none"> • Check the communication and earth cable connection and matching resistor settings. • Or contact SolaX for help if it can not return to normal.
IE 36	HardLimitFault	<p>HardLimitFault</p> <ul style="list-style-type: none"> • Check the power value set in the HardLimit setting, increase the value larger if needed. • Or contact SolaX for help if it can not return to normal.
IE 37	CTMeterConFault	<p>CT Meter ConFault</p> <ul style="list-style-type: none"> • Check if the CT or meter is well connected. • Or contact SolaX for help if it can not return to normal.
IE 100	PowerTypeFault	<p>Power type fault</p> <ul style="list-style-type: none"> • Upgrade the software and press the ESC key to restart the inverter. • Or contact SolaX for help if it can not return to normal.
IE 102	Mgr Eeprom Fault	<p>Manager EEPROM Fault.</p> <ul style="list-style-type: none"> • Shut down photovoltaic ,battery and grid, and then reconnect. • Or contact SolaX for help if it can not return to normal.
IE 104	NTC Sample Invalid	<p>NTC invalid</p> <ul style="list-style-type: none"> • Make sure the NTC is properly connected and the NTC is in good condition. • Please confirm that the installation environment is normal • Or contact SolaX for help if it can not return to normal.
IE 109	Meter Fault	<p>Meter Fault</p> <ul style="list-style-type: none"> • Check if the meter is working properly • Or contact SolaX for help if it can not return to normal.
IE 110	BypassRelayFlt	<p>Bypass relay fault</p> <ul style="list-style-type: none"> • Press the ESC key to restart the inverter. • Or contact SolaX for help if it can not return to normal.

Error Code	Fault	Descriptions and Diagnosis
IE 112	ARMParaComFlt	ARM Parameter Communication fault <ul style="list-style-type: none"> • Check that the communication cables of inverters are well connected and the baud rate of COMM setting of inverters are the same. • Or contact SolaX for help if it can not return to normal.
IE 113	FAN1 Fault	FAN1 Fault <ul style="list-style-type: none"> • Check if the foreign objects stuck in the fan. • Or contact SolaX for help.
IE114	FAN2 Fault	FAN2 Fault <ul style="list-style-type: none"> • Check if the foreign objects stuck in the fan. • Or contact SolaX for help.
IE111	FAN3 Fault	FAN3 Fault <ul style="list-style-type: none"> • Check if the foreign objects stuck in the fan. • Or contact SolaX for help.
BE 01	BMS1_ExtEr_Err	Battery Error - External Communication Fault <ul style="list-style-type: none"> • Please contact SolaX for help.
	BMS2_ExtEr_Err	
BE 02	BMS1_InterErr	Battery Error - Internal Communication Fault <ul style="list-style-type: none"> • Please contact SolaX for help.
	BMS2_InterErr	
BE 03	BMS1_OverVolt	Over voltage in battery system <ul style="list-style-type: none"> • Please contact SolaX for help.
	BMS2_OverVolt	
BE 04	BMS1_LowerVolt	Low voltage in battery system <ul style="list-style-type: none"> • Please contact SolaX for help.
	BMS2_LowerVolt	
BE 05	BMS1_ChargeOCP	Battery fault - over charge fault <ul style="list-style-type: none"> • Please contact SolaX for help.
	BMS2_ChargeOCP	
BE 06	DischargeOCP1	Battery fault-discharge over current fault <ul style="list-style-type: none"> • Please contact SolaX for help.
	DischargeOCP2	
BE 07	BMS1_TemHigh	Over temperature in battery system <ul style="list-style-type: none"> • Please contact SolaX for help.
	BMS2_TemHigh	
BE 08	BMS1_TempLow	Battery temperature sensor malfunction <ul style="list-style-type: none"> • Please contact SolaX for help.
	BMS2_TempLow	
BE 09	CellImbalance1	Battery Unbalanced Fault <ul style="list-style-type: none"> • Please contact SolaX for help.
	CellImbalance2	

Error Code	Fault	Descriptions and Diagnosis
BE 10	BMS1_Hardware	Battery hardware protection fault <ul style="list-style-type: none"> • Please contact SolaX for help.
	BMS2_Hardware	
BE 11	BMS1_Circuit	Battery circuit fault <ul style="list-style-type: none"> • Restart the battery. • Please contact SolaX for help.
	BMS2_Circuit	
BE 12	BMS1_ISO_Fault	Battery insulation fault <ul style="list-style-type: none"> • Check that the battery is properly grounded and restart the battery. • Please contact SolaX for help
	BMS2_ISO_Fault	
BE 13	BMS1_VolSen	Battery voltage sensor fault <ul style="list-style-type: none"> • Please contact SolaX for help
	BMS2_VolSen	
BE 14	BMS1_TempSen	Temperature sensor fault <ul style="list-style-type: none"> • Restart the battery. • Please contact SolaX for help.
	BMS2_TempSen	
BE 15	BMS1_CurSen	Battery current sensor fault <ul style="list-style-type: none"> • Please contact SolaX for help.
	BMS2_CurSen	
BE 16	BMS1_Relay	Battery relay fault <ul style="list-style-type: none"> • Please contact SolaX for help.
	BMS2_Relay	
BE 17	TypeUnmatched1	Battery type fault <ul style="list-style-type: none"> • Upgrade the battery BMS software. • Please contact SolaX for help.
	TypeUnmatched2	
BE 18	Ver Unmatched1	Battery version mismatch fault <ul style="list-style-type: none"> • Upgrade the battery BMS software. • Please contact SolaX for help.
	Ver Unmatched2	
BE 19	MFR Unmatched1	Battery manufacturer mismatch fault <ul style="list-style-type: none"> • Upgrade the battery BMS software. • Please contact SolaX for help.
	MFR Unmatched2	
BE 20	SW Unmatched1	Battery hardware and software mismatch fault <ul style="list-style-type: none"> • Upgrade the battery BMS software. • Please contact SolaX for help.
	SW Unmatched2	
BE 21	M&S Unmatched1	Battery master slave control mismatch fault <ul style="list-style-type: none"> • Upgrade the battery BMS software. • Please contact SolaX for help.
	M&S Unmatched2	
BE 22	CR NORespond1	Battery charging request no respond <ul style="list-style-type: none"> • Upgrade the battery BMS software. • Please contact SolaX for help.
	CR NORespond2	

Error Code	Fault	Descriptions and Diagnosis
BE 23	BMS1 SW Protect	Battery slave software protection failure <ul style="list-style-type: none"> • Upgrade the battery BMS software. • Please contact SolaX for help.
	BMS2 SW Protect	
BE 24	BMS1 536 Fault	Battery discharge over current fault <ul style="list-style-type: none"> • Please contact SolaX for help.
	BMS2 536 Fault	
BE 25	BMS1 SelfCheck	Over temperature in battery system <ul style="list-style-type: none"> • Please contact SolaX for help.
	BMS2 SelfCheck	
BE 26	BMS1 TempDiff	Battery temperature sensor malfunction <ul style="list-style-type: none"> • Please contact SolaX for help.
	BMS2 TempDiff	
BE 27	BMS1_BreakFault	Battery unbalanced Fault <ul style="list-style-type: none"> • Please contact SolaX for help.
	BMS2_BreakFault	
BE 28	BMS1_FlashFault	Battery hardware protection failure <ul style="list-style-type: none"> • Please contact SolaX for help.
	BMS2_FlashFault	
BE 29	BMS1_Precharge	Battery precharge fault <ul style="list-style-type: none"> • Please contact SolaX for help.
	BMS2_Precharge	
BE 30	AirSwitchBreak1	Battery air switch fault <ul style="list-style-type: none"> • Check if the battery breaker is off. • Please contact SolaX for help.
	AirSwitchBreak2	
BE 31	ClusterCntMIS1	Battery air switch fault <ul style="list-style-type: none"> • Check if the battery breaker is off. • Please contact SolaX for help.
	ClusterCntMIS2	
BE 32	ClusterComAddr1	Battery air switch fault <ul style="list-style-type: none"> • Check if the battery breaker is off. • Please contact SolaX for help.
	ClusterComAddr2	
IBE 01	BMS1 LOST	BMS communication loss fault <ul style="list-style-type: none"> • Please contact SolaX for help.
IBE 02	BMS2 LOST	BMS communication loss fault <ul style="list-style-type: none"> • Please contact SolaX for help.
/	Screen not on	<ul style="list-style-type: none"> • Check if the inverter correctly and normally connected to PV, battery or grid. • Contact SolaX for help if the inverter is connected correctly.
	Abnormal sound on fan	<ul style="list-style-type: none"> • Check if there is foreign objects stuck in the fan. • Contact SolaX for help.

Error Code	Fault	Descriptions and Diagnosis
/	Screen on but no content display	<ul style="list-style-type: none"> • Contact SolaX for help.
/	LCD screen stuck in Wait state	<p>Check if the input voltage of battery or PV is greater than 180 V.</p> <ul style="list-style-type: none"> • If it meets the requirement, contact SolaX for help. • If the input voltage of battery or PV is less than 180 V, check the corresponding connection.
/	No readings after CT connection	<ul style="list-style-type: none"> • Check if CT is correctly clipped on the L wire • Check if the arrow on the CT points at Grid. • Contact SolaX for help if it can not return to normal.
/	No readings on Load (on App or Web)	<ul style="list-style-type: none"> • Check if the load is connected correctly. • Check if the power of load on the LCD screen displays normally. • Check if the monitoring module works normally. • Contact SolaX for help if it can not return to normal.
/	No readings on Grid (on App or Web)	<ul style="list-style-type: none"> • Check if the grid connection is normal. • Check if the grid parameter on the LCD screen displays normally. • Check if the monitoring module works normally. • Contact SolaX for help if it can not return to normal.
/	No readings on battery (on App or Web)	<ul style="list-style-type: none"> • Check if the battery is connected correctly. • Check if the battery parameter on the LCD screen displays normally. • Check if the monitoring module works normally. • Contact SolaX for help if it can not return to normal.
/	No Feedin data (on App or Web)	<ul style="list-style-type: none"> • Check if the meter/CT is connected correctly. • Check if the meter/CT parameter on the LCD screen displays normally. • Check if the monitoring module works normally. • Contact SolaX for help if it can not return to normal.
/	No data on App or Web	<ul style="list-style-type: none"> • Check if the monitoring module works normally. • Contact SolaX for help.
	No display on meter after power on	<ul style="list-style-type: none"> • If the meter connection is abnormal, reconnect them according to the wiring diagrams. • Wait for the grid voltage to restore. • Contact SolaX for help if it can not return to normal.

Error Code	Fault	Descriptions and Diagnosis
	Abnormal electrical data on meter	<ul style="list-style-type: none"> • If the wiring is incorrect, reconnect them based on the wiring diagrams. • Set the voltage and current ratio according to the setting steps of meter user manual. • Contact SolaX for help if it can not return to normal.

12.3 Meter/CT Fault

Table 12-1 Troubleshooting list

Error Code	Fault
0	CT not connected on Phase A.
1	Phase A has two CTs connected, or a CT connected to Neutral (N) phase.
2	CT1 is simultaneously on Phase A and Phase B.
3	CT2 is simultaneously on Phase A and Phase B.
4	CT3 is simultaneously on Phase A and Phase B.
5	CT not connected on Phase B.
6	Phase B has two CTs connected, or a CT connected to Neutral (N) phase.
7	CT1 is simultaneously on Phase A and Phase C.
8	CT2 is connected to Phase A, while CT1 is simultaneously connected to Phase B and Phase C.
9	CT3 is connected to Phase A, while CT1 is simultaneously connected to Phase B and Phase C.
10	CT2 is simultaneously connected to Phase A and Phase C.
11	CT1 is connected to Phase A, while CT2 is simultaneously connected to Phase B and Phase C.
12	CT3 is connected to Phase A, while CT2 is simultaneously connected to Phase B and Phase C.
13	CT3 is simultaneously on Phase A and Phase C.
14	CT1 is connected to Phase A, while CT3 is simultaneously connected to Phase B and Phase C.
15	CT2 is connected to Phase A, while CT3 is simultaneously connected to Phase B and Phase C.
16	CT not connected on Phase C.

Error Code	Fault
17	Phase C has two CTs connected, or a CT connected to Neutral (N) phase.
18	No reactive power detected on Phase A after adjusting the CT sequence.
19	No reactive power detected on Phase B after adjusting the CT sequence.
20	No reactive power detected on Phase C after adjusting the CT sequence.
21~31	Reserved
32	DSP has no power or DSP has no program.

NOTICE!

- If no corresponding installation errors are found after self inspection, and when inverter is not producing, please check whether the readings of the three phases in Status-Meter/CT on the inverter screen match the actual situation. If there are no problems, please disable the Installation Check and Cyclic Check in the Meter/CT setting-Meter/CT check or contact Solax technical support.

12.4 Maintenance

Regular maintenance is required for the inverter. Please check and maintain the following items based on the instructions below to ensure the optimal performance of the inverter. For inverters working in inferior conditions, more frequent maintenance is required. Please keep maintenance records.

! WARNING!

- Only qualified person can perform the maintenance for the inverter.
- Only spare parts and accessories authorized by SolaX can be used for maintenance.

12.4.1 Maintenance routines

Table 12-2 Proposal of Maintenance

Item	Check Notes	Maintenance Interval
Fans	<ul style="list-style-type: none"> • Check if the cooling fans on the bottom of the inverter are covered by dirt or if there is abnormal sound. • Clean the cooling fans with a soft dry cloth or brush or replace it if necessary. 	Every 12 months

Electrical connection	<ul style="list-style-type: none"> Ensure that all cables are firmly connected. Check the integrity of the cables, ensuring that there are no scratches on the parts touching the metallic surface. Verify that the sealing caps on idle terminals are not falling off. 	Every 12 months
Grounding reliability	<ul style="list-style-type: none"> Check whether the ground terminal and ground cable are securely connected. Use Ground Resistance Tester to test the ground resistance from inverter enclosure to PE bar in the power distribution box. 	Every 12 months
Heat sink	<ul style="list-style-type: none"> Check whether the heat sink is covered with foreign objects. 	Every 12 months
General status of inverter	<ul style="list-style-type: none"> Check if there is any damage on the inverter. Check if there is any abnormal sound when the inverter is running. 	Every 6 months

12.4.2 Replacement of Fans

When the fan is not rotating and the feedback speed of the fan is 0, the LCD screen will display FAN1FAULT / FAN2FAULT / FAN3FAULT error. Refer to the following steps for replacement.

Step 1: Loosen the screw on the inverter with cross screwdriver, remove the outer casing of the inverter, proceed to disconnect the terminals that are connected to the fans.

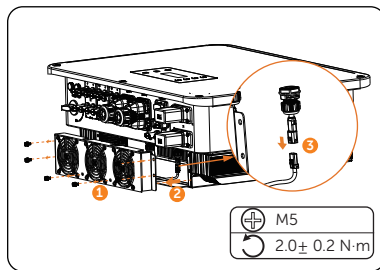

Figure 12-1 Disconnect the fans connectors

Step 2: Loosen the screws on the fan assembly and after disassembling it, replace the fans. Before replacement, make sure that the new fan can operate normally.

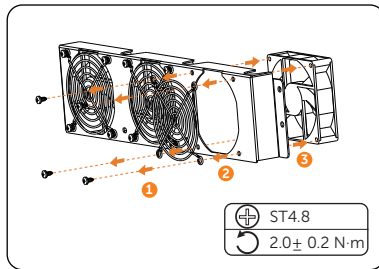

Figure 12-2 Replace the fan

Step 3: After replacing the fan, proceed to reassemble the components in their respective order.

12.4.3 Upgrading Firmware

WARNING!

- Make sure that the type and format of the firmware file are correct. Do not modify the file name. Otherwise, the inverter may not work properly.
- Do not modify the folder name and file path where the firmware files are located, as this may cause the upgrade to fail.

WARNING!

- Before upgrading, ensure that the PV input voltage is higher than 180 V (preferably on sunny day), or that the battery SOC is higher than 20%, or the battery input voltage is higher than 180 V. Failure to meet one of these conditions may result in upgrade process failure.

Upgrade preparation

- Prepare a USB drive (USB 2.0/3.0, ≤32 GB, FAT 16/32).
- Check for the current firmware version of the inverter.
- Contact our service support for the update firmware file, and save it to the USB drive.
 - » For ARM file: XXX.XXXXX.XX_XXX_3P_ARM_VXXX.XX_XXXX.usb
 - » For DSP file: XXX.XXXXX.XX_XXX_3P_DSP_VXXX.XX_XXXX.usb
- Check the folder name and file path:

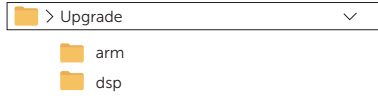

Figure 12-3 Folder name and path

Upgrade steps

- a. Press and hold the **Enter** key on the inverter LCD for 5 seconds to enter the **OFF** mode.
- b. Remove the dongle from the Dongle terminal of the inverter by hand, and then insert the USB drive. The inverter will automatically display the **Upgrade Selection** interface. (For the position of Dongle terminal, see "8.1.1 Terminals of Inverter".)
- c. On the **Upgrade Selection** interface, select **ARM** or **DSP** based on the file type, and then tap **OK**.



- d. Select and confirm the firmware version, and then tap the **Enter** key to start updating. ARM update takes about 20 seconds, and DSP update takes about 2 minutes.

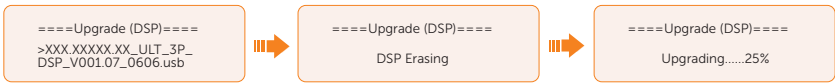
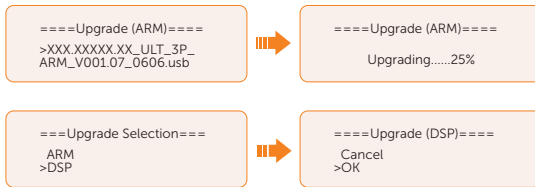

- e. After the upgrade is completed, the LCD screen displays **Upgrade Successful**. If the upgrades fail, the LCD screen displays **Upgrade failed**.

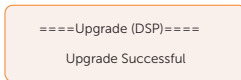

CAUTION!

- If the ARM firmware upgrade fails or stops, do not unplug the U disk. Please power off the inverter and restart it. Then repeat the upgrade steps.

 CAUTION!

If the DSP firmware upgrade fails or stops, perform operations below to troubleshoot:

- Check if the DC switch is turned off. If it is off, turn it on.
- (Recommended) If the DC switch is already on, check if the battery and PV parameters in **Menu>System Status** meets the upgrade requirements (The PV or battery input voltage should be larger than 180 V, or the battery SOC be higher than 20%).
- Alternatively, select **Menu > Mode Select > Manual > Forced Charge** to charge the battery. This process can help wake up the battery for DSP upgrade.

NOTICE!

- If the display screen is stuck after the upgrade, please turn off the DC switch and restart, and the inverter will restart and return to normal. If not, please contact us for help.

13 Decommissioning

13.1 Disassembling the Inverter

WARNING!

- When disassembling the inverter, strictly follow the steps as below.

NOTICE!

- The AC terminals, battery terminals, and PV terminals should be disassembled using the dedicated disassembly tool provided with the package. This is to prevent any damage to the equipment or potential injury to personnel.

Step 1: Turn off the inverter LCD screen.

Step 2: Disconnect the external AC breaker and AC cable of the inverter.

Step 3: Turn the "DC" switch to "OFF" position.

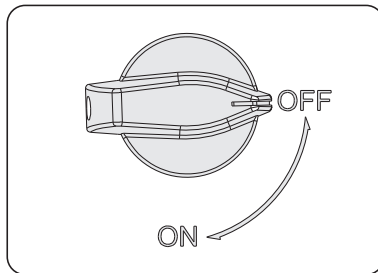

Figure 13-1 Turning off the DC switch

Step 4: Turn off the battery switch / button / breaker (if any). (See documents of battery)

Step 5: Wait until the LCD screen turns off.

Step 6: Disconnect the PV connectors: Insert the removal tool into the notch of PV connectors and slight pull out the connectors.

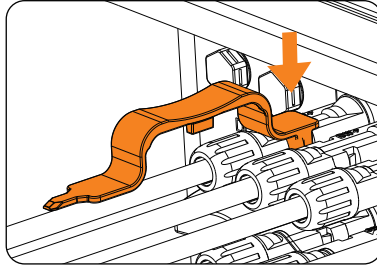

Figure 13-2 Releasing the PV connector

Step 7: Slight pull the dongle module.

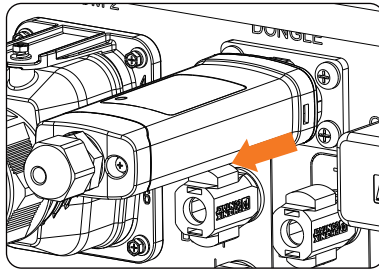

Figure 13-3 Removing the dongle

Step 8: Disconnect the battery connectors: Insert the removal tool into the notch of connectors and slight pull the connectors.

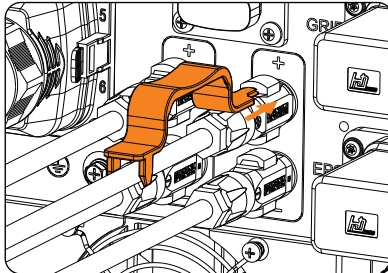

Figure 13-4 Removing the Battery connector

Step 9: Disconnect the AC connector: Insert the removal tool to the slot of the AC connector to release it. Slight pull the connectors.

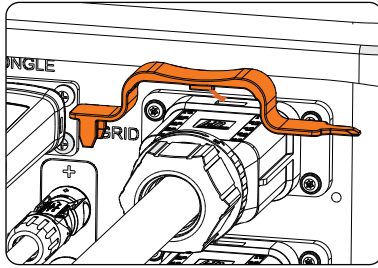

Figure 13-5 Removing AC connector

Step 10: Remove the swivel nut. Align the removal tool (part U or part X) with the core slot, insert it

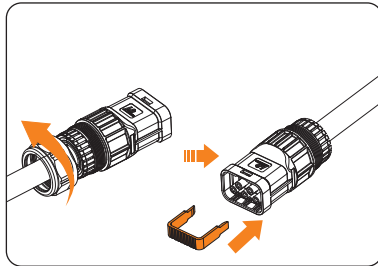

Figure 13-6 Remove the swivel nut

Step 11: Press down with one hand, and push the wire upwards with the other hand to disconnect the AC connector.

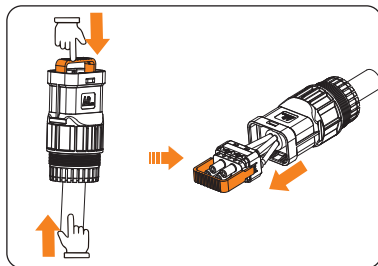

Figure 13-7 disconnect the AC connector

Step 12: Disconnect the COM 1 connector and COM 2 connector: Please loosen the swivel nut of the COM connector and anti-clockwise loosen M3 screw of the communication connector by cross screwdriver. Pinch the tabs on the sides of the connector and pull the connector at the same time to remove it.

Step 13: Put the original terminal cap on the terminals.

Step 14: Unscrew the grounding screw by crosshead screw and remove the grounding

cable.

Step 15: Unlock the anti-theft lock if you installed it. Unscrew the M5 screw on the sides of inverter and vertically lift up the inverter to dismantle the inverter.

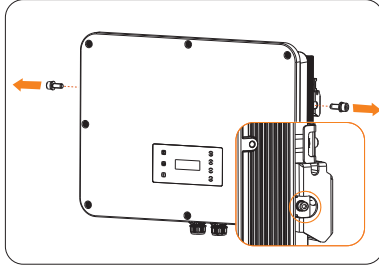

Figure 13-8 Unscrewing the M5 screws

Step 16: Unscrew the screws for fastening the Bracket and remove the Bracket.

13.2 Packing the Inverter

- Load the inverter into the original packing material if possible.

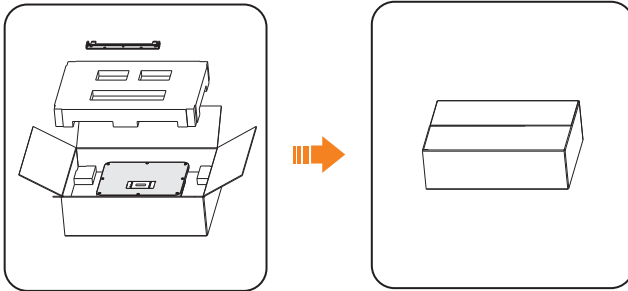

Figure 13-9 Packing the inverter

- If the original packing material is not available, use the packing material which meets the following requirements:
 - » Suitable weight and dimensions for inverter.
 - » Easy to carry
 - » Be capable of being closed completely

13.3 Disposing of the Inverter

Please dispose of the inverters or accessories in accordance with the electronic waste disposal regulations applicable at the installation site.

14 Technical Data

• INPUT PV

Model	X3-ULT-15KP	X3-ULT-15K	X3-ULT-19.9K	X3-ULT-20K	X3-ULT-20KP	X3-ULT-25K	X3-ULT-30K
Max. PV array power [Wp]	30000	30000	40000	40000	40000	50000	60000
Max.input PV power [W]	30000	30000	40000	40000	40000	50000	60000
Max. DC voltage¹ [V]				1000			
Normal DC operating voltage [V]				600			
No. of MPP trackers / Strings per MPP tracker	3 (2 / 2 / 2)	2 (2 / 2)	2 (2 / 2)	2 (2 / 2)	3 (2 / 2 / 2)	3 (2 / 2 / 2)	3 (2 / 2 / 2)
Max. input current (input PV1/input PV2/input PV3)² [A]	36 / 36 / 36	36 / 36	36 / 36	36 / 36	36 / 36 / 36	36 / 36 / 36	36 / 36 / 36
Max. short circuit current (input PV1/ input PV2/input PV3) [A]	45 / 45 / 45	45 / 45	45 / 45	45 / 45	45 / 45 / 45	45 / 45 / 45	45 / 45 / 45
MPPT operating voltage range³ [V]				160-950			
Start output voltage [V]				200			
Shutdown input voltage[V]				130			
Max. inverter backfeed current to the array [A]				0			

Note:

¹ The maximum input voltage is the upper limit of the DC voltage. Any higher input DC voltage would probably damage inverter.

² PV3 Only available for 15KP, 20KP, 25K and 30K. When both strings are connected to a single MPPT, the Max. output current for a single string is 18A; When a single string is connected to one MPPT, the Max output current for a single string is 20A.

³ Input voltage exceeding the operating voltage range may triggers inverter protection.

Technical Data

• OUTPUT AC (On - Grid)

Model	X3-ULT-15KP	X3-ULT-15K	X3-ULT-19.9K	X3-ULT-20K	X3-ULT-20KP	X3-ULT-25K	X3-ULT-30K
Normal AC power [VA]	15000 (14999 for AS 4777)	15000 (14999 for AS 4777)	19999	20000	20000	25000 (24900 for VDE 4105)	30000 (29999 for AS 4777, 29900 for VDE 4105)
Max. apparent AC power [VA] (below +40°C)	16500 (14999 for AS 4777)	16500 (14999 for AS 4777)	19999	22000	22000	25000 (24900 for VDE 4105)	30000 (29999 for AS 4777, 29900 for VDE 4105)
Rated grid voltage (AC voltage range) [V]	3P4W, 400 / 230, 380 / 220						
Current (inrush) [A]	65						
Rated grid Frequency [Hz]	50 / 60						
Normal AC current [A](230V)	21.8	21.8	29.0	29.0	29.0	36.3	43.5
Max. AC current [A](above rated current, de-rating is acceptable) (230V)	24.0 (21.8 for AS 4777)	24.0 (21.8 for AS 4777)	29.0	31.9	31.9	39.9 (36.3 for VDE 4105)	43.5
Displacement power factor	1 (-0.8 ~ 0.8)						
Total harmonic distortion (THDi, rated power)	< 3%						
Maximum out fault current [A]	175						
Maximum output overcurrent protection [A]	181						

• INPUT AC

Model	X3-ULT-15KP	X3-ULT-15K	X3-ULT-19.9K	X3-ULT-20K	X3-ULT-20KP	X3-ULT-25K	X3-ULT-30K
Normal AC power [VA]	15000	15000	19999	20000	20000	25000	30000
Normal AC current [A]	21.8	21.8	29.0	29.0	29.0	36.3	43.5
Rated grid voltage (AC voltage range) [V]	3P4W, 400 / 230, 380/220						
Rated grid Frequency [Hz]	50 / 60						

• BATTERY

Model	X3-ULT-15KP	X3-ULT-15K	X3-ULT-19.9K	X3-ULT-20K	X3-ULT-20KP	X3-ULT-25K	X3-ULT-30K
Battery type	Lithium - ion						
Battery voltage range [V]	180 - 800						
Max.charge / discharge power [kW]	15 / 15	15 / 15	20 / 20	20 / 20	20 / 20	24 / 24	30 / 30
Max.charge / discharge current [A]	60 (30 * 2)						
Number of connectable batteries	2						

• EPS OUTPUT (WITH BATTERY)

Model	X3-ULT-15KP	X3-ULT-15K	X3-ULT-19.9K	X3-ULT-20K	X3-ULT-20KP	X3-ULT-25K	X3-ULT-30K
EPS peak power [VA]	2 time of rated power, 10s						
EPS rated power [VA]	15000	15000	19999	20000	20000	25000	30000
EPS rated voltage [V], Frequency [Hz]	400/230, 50 / 60						
EPS rated current [A] [220V]	22.8	22.8	30.4	30.4	30.4	37.9	45.5
EPS rated current [A] [230V]	21.8	21.8	29.0	29.0	29.0	36.3	43.5
Switchover time [ms]	< 10						
Total harmonic distortion (THDv, linear Load)	< 3%						

• EFFICIENCY

Model	X3-ULT-15KP	X3-ULT-15K	X3-ULT-19.9K	X3-ULT-20K	X3-ULT-20KP	X3-ULT-25K	X3-ULT-30K
MPPT efficiency	99.9%						
Max. efficiency	98.00%						
European efficiency	97.7%						
Rated Battery charge efficiency	98.5%						
Rated Battery discharge efficiency	97.0%						

Technical Data

- POWER CONSUMPTION

Model	X3-ULT-15KP	X3-ULT-15K	X3-ULT-19.9K	X3-ULT-20K	X3-ULT-20KP	X3-ULT-25K	X3-ULT-30K
Internal consumption (night) [W]				< 5			

- PROTECTION

Model	X3-ULT-15KP	X3-ULT-15K	X3-ULT-19.9K	X3-ULT-20K	X3-ULT-20KP	X3-ULT-25K	X3-ULT-30K
Anti-Islanding protection				Yes			
DC reverse polarity protection				Yes			
Insulation monitoring				Yes			
Residual current monitoring				Yes			
AC overcurrent protection				Yes			
AC short-circuit protection				Yes			
AC overvoltage protection				Yes			
Over-heat protection				Yes			
AFCI	F-I- AFPE-1-2-3	F-I- AFPE-1-2-2	F-I- AFPE-1-2-2	F-I- AFPE-1-2-2	F-I- AFPE-1-2-3	F-I- AFPE-1-2-3	F-I- AFPE-1-2-3
Battery reverse charging from grid				Yes			
surge protection				Type II, DC and AC			

- ENVIRONMENT LIMIT

Model	X3-ULT-15KP	X3-ULT-15K	X3-ULT-19.9K	X3-ULT-20K	X3-ULT-20KP	X3-ULT-25K	X3-ULT-30K
Protection class				IP66			
Operating temperature range [C]				-35 ~ 60 (Derating above +45)			
Humidity [%]				0 ~ 100			
Altitude [m]				< 3000			
Storage temperature [C]				-40 ~ +70			
Noise emission (typical) [dB]				< 45			
Over voltage category				PV: II ; Main: III			

• GENERAL

Model	X3-ULT-15KP	X3-ULT-15K	X3-ULT-19.9K	X3-ULT-20K	X3-ULT-20KP	X3-ULT-25K	X3-ULT-30K
Dimensions (W*H*D) [mm]	696 * 526 * 240						
Weight [kg]	47						
Cooling concept	Smart cooling						
Topology	Transformerless						
Communication	Modbus (RS485), Meter (RS485), DI * 5, DO * 2						
LCD display	Yes						

• STANDARD

Model	X3-ULT-15KP	X3-ULT-15K	X3-ULT-19.9K	X3-ULT-20K	X3-ULT-20KP	X3-ULT-25K	X3-ULT-30K
Safety	EN / IEC 62109 -1 / -2						
EMC	EN61000-6-1/2/3/4; EN61000-3-11/12; EN 5011; IEC 62920						
Cetification	VDE4105 / G99 / AS4777 / EN50549 / CEI 0-21 / IEC61727 / PEA / MEA / NRS-097-2-1 / RD1699 / TOR						

* The specific gross weight is subject to the actual situation of the whole machine.

15 Appendix

15.1 Application of Generator

15.1.1 Introduction of generator application

In certain regions where utility power is unstable, the use of generators becomes necessary to ensure uninterrupted operation of loads. The characteristic of this system is its ability to seamlessly switch to generators combined with an energy storage system, forming a new power supply configuration in the absence of utility power.

A diesel generator is employed to replicate grid-like functionality, while a hybrid inverter converts solar energy into usable electric energy.

15.1.2 Notice for generator application

- Note 1: The generator should be equipped with an ATS, enabling it to start automatically in the event of a power outage.
- Note 2: The rated output power of the generator should be greater than the sum of the load power and the battery charging power. If there are two inverters in parallel, the rated output power of the generator should be greater than the sum of the load power and the battery charging power of the two inverters.
- Note 3: If the rated output power of the generator is small and cannot meet the requirements of Note 2, the setting value of **MaxChargePower** can be changed in the **Menu>Setting>Advance Setting>ExternalGen** to ensure that the generator power can meet the load and battery charging use at the same time.
- Note 4: The EPS load power cannot be greater than the battery discharge power to prevent the battery power from being unable to meet the EPS load after the generator shuts down and the inverter will report **Overload fault**. If two inverters are paralleled, the EPS load power shall be doubled.

15.1.3 ATS control mode

In this operating mode, the generator functions as a substitute for the grid. There is no communication between the generator and the inverter, which means no wiring modifications are required (however, the inverter is also unable to control the generator). The ATS that accompanies the generator will determine whether the generator should be turned on or off based on the status of the grid.

Wiring connection diagram

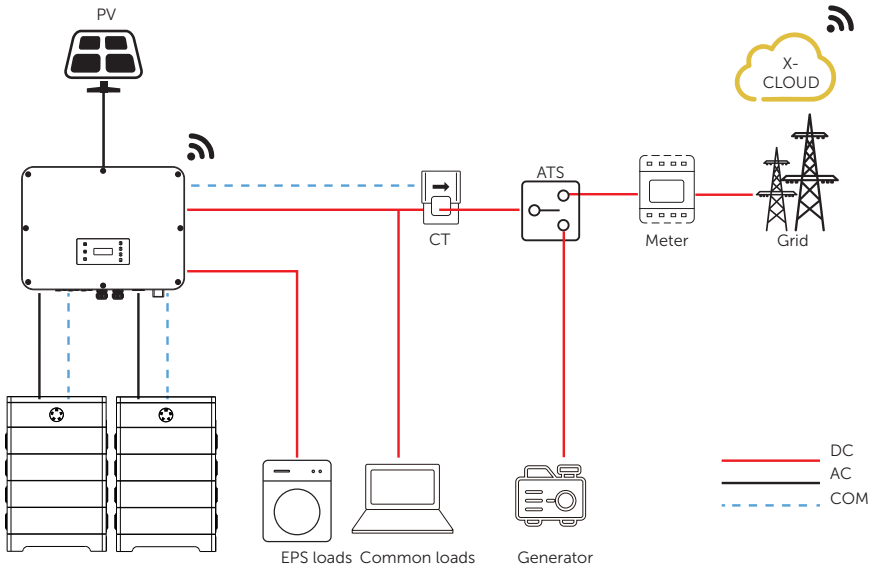

Figure 15-1 ATS control wiring diagram

Inverter settings for ATS control mode

- a. Select **Menu>Setting>Advance Setting>ExternalGen>ATS Control**.

```
====ExternalGen====
>Function Control
  ATS Control
```

- b. Set the relative parameters as below in accordance with actual needs.

- » **MaxChargePower**: Maximum battery charging power from generator. (0-30000 W, 5000 W by default)

```
====ExternalGen====
>MaxChargePower
  XXXXW
```

- » **Char&Disc Period**: Including **Forced Charge Period** and **Allowed Disc Period**. Two periods can be set. These period settings are associated with the same settings under **Work Mode** for no need to jump to work mode page to set the working period when using generator mode.



- » **Charge from Gen and Charge battery to:** The SOC which allows the system charging from generator. (10-100%, 10% by default)

15.1.4 Dry contact mode

In this operating mode, users can intelligently control the system by establishing a dry contact connection between the inverter and the generator. It allows for adjustments to multiple settings so that the system can meet the requirements of different scenarios.

Wiring connection diagram

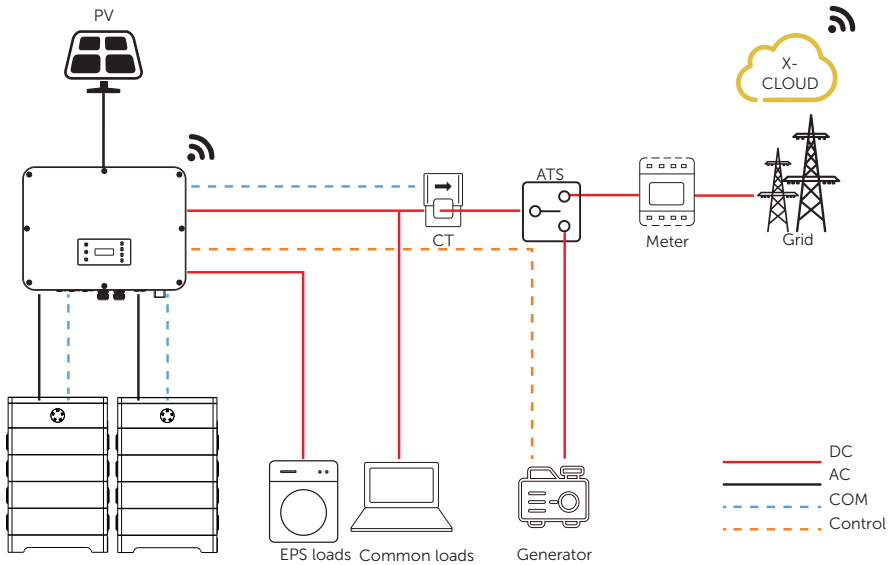

Figure 15-2 Dry contact wiring diagram

Inverter connection for dry contact mode

- Connection terminal-DIO terminal

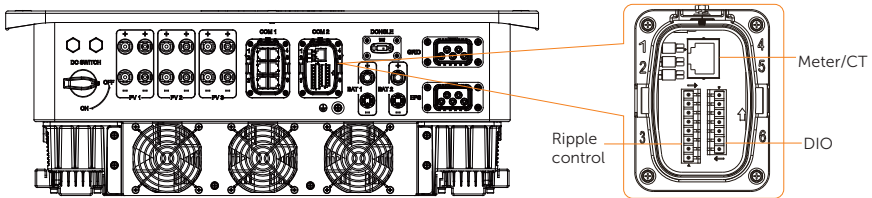

Figure 15-3 Connection terminal for generator

- Connection pins-Pin 1 and Pin 2

Table 15-1 Connection pins for generator

Application	Generator dry contact output		System switch dry contact input		Reserved		
Pin	1	2	3	4	5	6	7
Assignment	DO_1	DO_2	DI_1+	DI_1-	DI_2+	DI_2-	GND_COM

- Connection steps: Please refer to "8.7.4 DIO Communication Connection" for specific wire making and connection.
- Inverter settings for dry contact mode
 - Select **Menu>Setting>Advance Setting>ExternalGen>Dry Contact**.

```
====ExternalGen====
>Function Control
  Dry Contact
```

- Set the relative parameters in accordance with actual needs.

- » **MaxChargePower**: Maximum battery charging power from generator. (0-30000 W, 5000W by default).

```
====ExternalGen====
>MaxChargePower
  5000W
```

- » **Start Gen Method**: **Reference SOC** and **Immediately** can be selected. **Reference SOC**: Turn on/off generator according to the set **Switch on/off SOC**. **Immediately**: Turn on /off the generator when grid status changed.

```
====ExternalGen====
>Start Gen Method
  Reference soc
```

```
====ExternalGen====
>Start Gen Method
  Immediately
```

- » **Switch on/off SOC**: the option is activated when you select **Reference SOC**

for **Start Gen Method**. Inverter will turn on the generator when the battery reaches the set **Switch on SOC** and turn it off when the battery reaches the set **Switch off SOC**.

```
====ExternalGen====  
>Switch on SoC  
0%
```

```
====ExternalGen====  
>Switch off SoC  
0%
```

- » **MaxRunTime**: Maximum operating time of generator. (30 Min by default)

```
====ExternalGen====  
>MaxRunTime  
30Min
```

- » **MinRestTime**: Minimum time interval for two consecutive starts to avoid frequent generator on and off.

```
====ExternalGen====  
>MaxRestTime  
0Min
```

- » **Char&Disc Period**: Including **Forced Charge Period** and **Allowed Disc Period**. Two periods can be set. These period settings are associated with the same settings under **Work Mode** for no need to jump to work mode page to set the working period when using generator mode.

```
====ExternalGen====  
>Forced Charge Period  
Start Time  
00:00
```

```
====ExternalGen====  
>Allowed Disc Period  
Start Time  
00:00
```

```
====ExternalGen====  
>Forced Charge Period  
End Time  
00:00
```

```
====ExternalGen====  
>Allowed Disc Period  
End Time  
00:00
```

- » **Allow Work**: Allowed time period for generator operating. You can set the start time and end time.

```
====ExternalGen====  
>Allow Work  
Start Time  
00:00
```

```
====ExternalGen====  
>Allow Work  
End Time  
00:00
```

- » **Charge from Gen and Charge battery to**: The SOC which allows the system charging from generator. (10-100 W from generator, 10% by default)

```
====ExternalGen====  
Charge from GEN  
> Enable <
```



```
====ExternalGen====  
>Charge battery to  
10%
```

15.2 Application of Adapter Box G2

15.2.1 Introduction of Adapter Box G2 application

With the SolaX Adapter Box G2, users can effectively utilize solar energy by commanding it to power their heat pump using settings available on the SolaX inverter and SolaXCloud. This intelligent integration allows for optimized solar self-consumption and ultimately helps in reducing electricity bills.

Wiring connection diagram

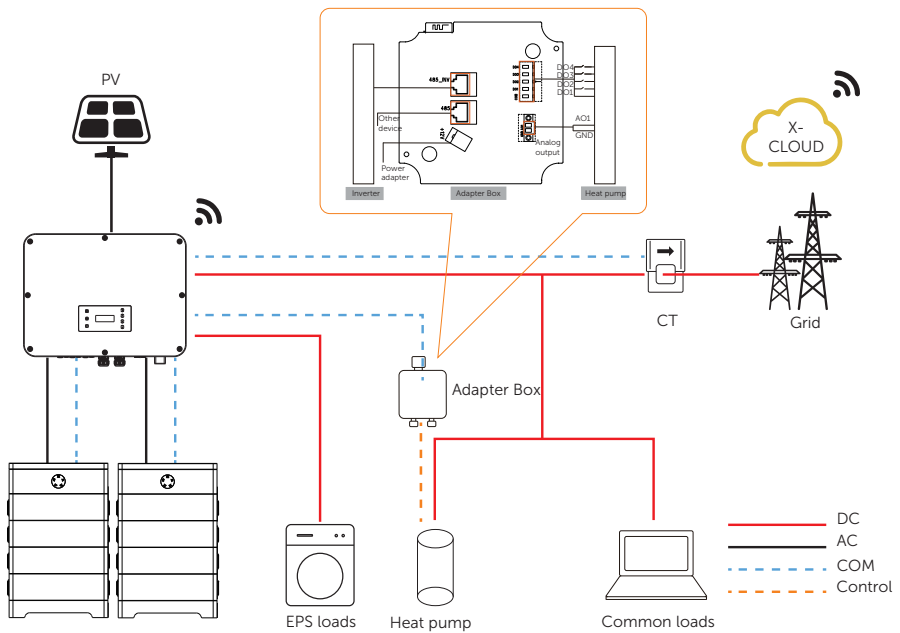

Figure 15-4 Adapter Box wiring diagram

The inverter communicates with Adapter Box via RS485. In case of excess power, the Adapter Box can utilize it to heat the pump through the connection of dry contacts, SG Ready, or Analog output between the Adapter Box and the heat pump. To power the Adapter Box, an external power adapter is required as the inverter itself cannot supply power to the Adapter Box.

15.2.2 Communication connection with inverter

- Connection terminal-RS485 terminal

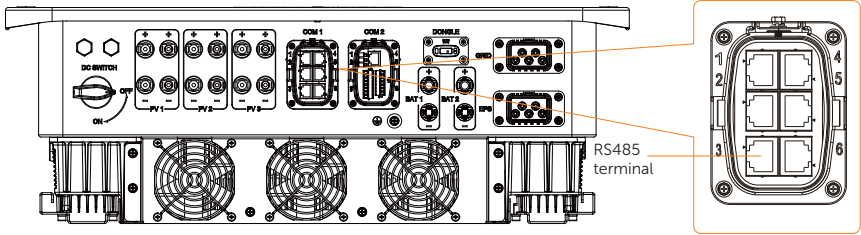

Figure 15-5 Connection terminal for Adapter Box

- Connection pins

Table 15-2 Pin-to-pin connection for inverter and Adapter Box G2

RS485 terminal of inverter		RS485_INV terminal of Adapter Box G2	
Pin	Pin assignment	Pin	Pin assignment
3/4	Parallel_485AA	4	RS485-A
5/6	Parallel_485BB	5	RS485-B

- Connection steps-Please refer to "8.6.4 RS485 Communication Connection" for specific wire making and connection

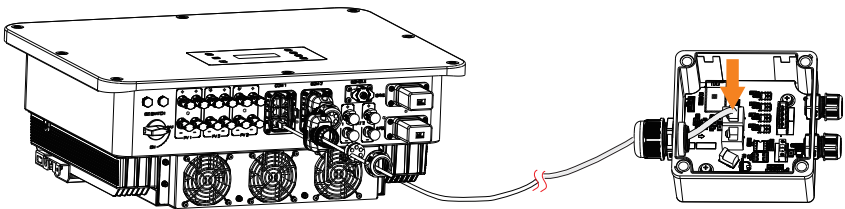

Figure 15-6 Connecting to Adapter Box

NOTICE!

- Please refer to *Adapter Box G2 User Manual* for specific connection between power adapter and Adapter Box G2 and between heat pump and Adapter Box G2.

Settings for Adapter Box

Setting path: **Menu>Setting>Advance Setting>Internal485**

- Select **Menu>Setting>Advance Setting>Internal485**;
- Select the **AdapBox G2** and set the **Baud Rate** and corresponding Address. The default **Baud Rate** is 9600.

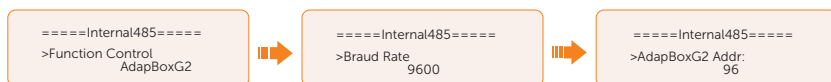

NOTICE!

- When two equipments need to be connected at the same time, the braud rate and address of the two equipments shall be set to the same.

- Check the connectiong status.

```

=====Internal485=====
>AdapBox G2 COM STAT
  Connected
  
```

NOTICE!

- For specific wiring and setting procedures of Adapter Box G2, see *Adapter Box G2 User Manual*.

15.3 Application of EV-Charger

15.3.1 Introduction of EV-Charger application

The EV-Charger is intended for charging electric vehicles. It should be installed in a fixed location and connected to the AC supply. The EV-Charger can communicate with other devices or systems (inverter, meter, CT, third-party charger management platform, etc.) to realize intelligent control of charging process.

15.3.2 Wiring connection diagram

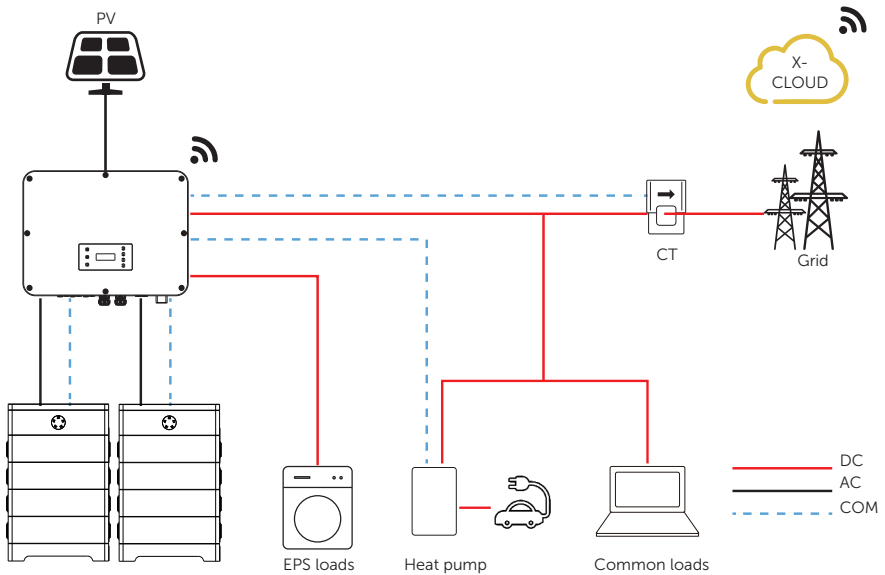

Figure 15-7 EV-Charger wiring diagram

15.3.3 Charging modes

- Green mode: In Green mode, the EV-Charger will maximize the use of surplus power generated from the inverter. According to the minimum start-up charging power, the charging current can be divided into two levels as 3 A and 6 A. The default level is 3 A. If at any time, the available surplus power falls below the minimum start-up charging power, the EV-Charger will stop charging.
- Eco mode: In Eco mode, the charging power is continuously adjusted according to changes in generation or power consumption elsewhere in the house, thereby minimizing the use of the grid power. In this mode, users can set charging current at five different levels, i.e. 6 A, 10 A, 16 A, 20 A and 25 A (Only 6 A & 10 A for 11 kW

models). If at any time, the available surplus power falls below the minimum start-up charging power, such as 4.2 kW for three-phase, the shortfall will be drawn from the grid.

- Fast mode (Default mode): In Fast mode, the EV-Charger will charge the EV at the fastest rate regardless of whether the power generated by PV is sufficient and import grid electricity if the power generated by PV is insufficient

15.3.4 Communication connection with inverter

- Connection terminal-RS485 terminal

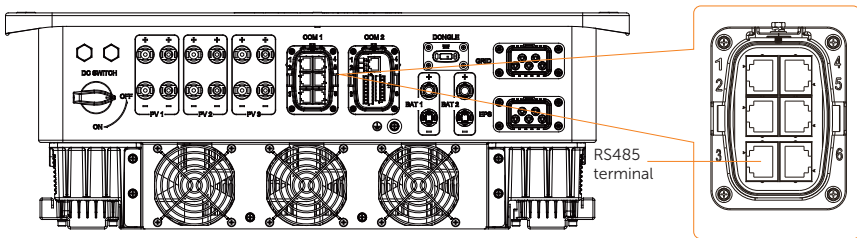

Figure 15-8 Connection terminal for EV-Charger

- Connection pins

Table 15-3 Pin-to-pin connection for inverter and EV-Charger

RS485 terminal of inverter		COM terminal of EV-Charger	
Pin	Pin assignment	Pin	Pin assignment
3/4	Parallel_485AA	5	B1
5/6	Parallel_485BB	4	A1

- Connection steps-Please refer to "[8.6.4 RS485 Communication Connection](#)" for specific wire making and connection.

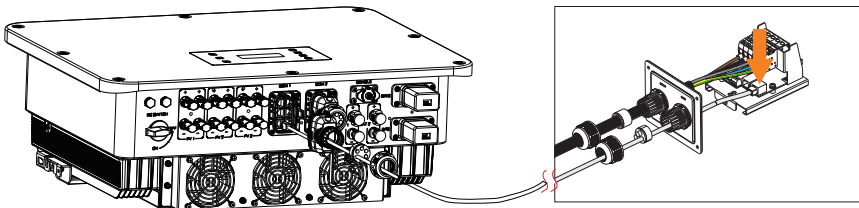

Figure 15-9 Connecting to EV-Charger

NOTICE!

- The EV-Charger in the connection diagram is the home version, and both the home version and fusion version of SolaX's EV-Charger are compatible with X3-ULTRA.

15.3.5 Setting for EV-Charger

- Select **Menu>Setting>Advance Setting>Internal485**;
- Select the **EV Charger** and set the **Baud Rate** and corresponding Address. The default **Baud Rate** is 9600.

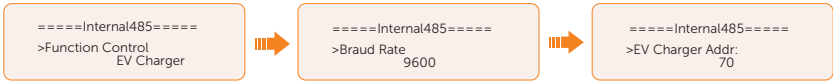

NOTICE!

- When two equipments need to be connected at the same time, the braud rate and address of the two equipments shall be set to the same.

- Check the connecting status.

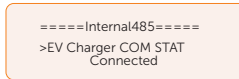

- You can enable **Battery Charge EVC** to allow the battery to discharge energy to EV-Charger through setting path: **Menu>Setting>Advance Setting>Battery Charge EVC**.

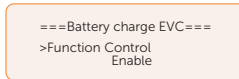

NOTICE!

- For specific wiring and setting procedures of EV-Charger, see *X1/X3-EVC Series User Manual*.

15.4 Application of DataHub

15.4.1 Introduction of DataHub application

SolaX DataHub can be connected to inverters through RS485 to control the output power of the entire power station according to on-site requirements. Besides, it can work with SolaXCloud to monitor all inverters, allowing for real-time data display and device management. In the entire system, a maximum of 10 X3-ULTRA series inverters can be connected to the DataHub.

15.4.2 Wiring connection diagram

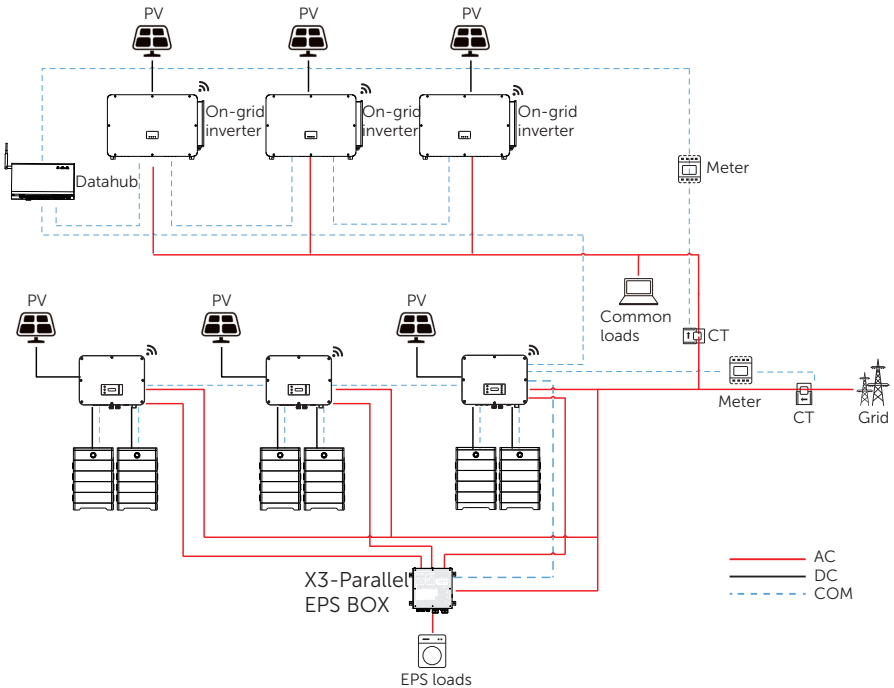

Figure 15-10 Datahub wiring diagram

15.4.3 Communication connection with inverter

- Connection terminal-RS485 terminal

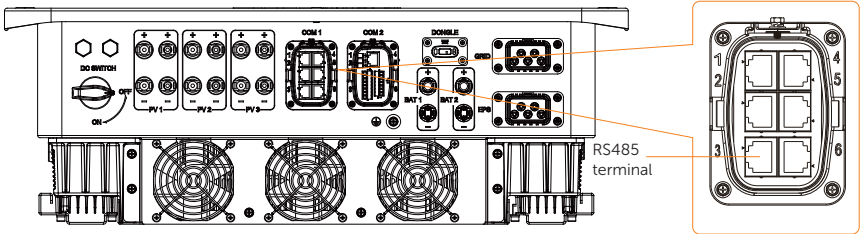

Figure 15-11 Connecting terminal for Datahub

- Connection pins

Table 15-4 Pin-to-pin connection for inverter and DataHub

RS485 terminal of inverter		RS485-1 terminal of DataHub	
Pin	Pin assignment	Pin	Pin assignment
3/4	ParalleL_485AA	/	A+
5/6	ParalleL_485BB	/	B-

- Connection steps-Please refer to "8.6.4 RS485 Communication Connection" for specific wire making and connection.

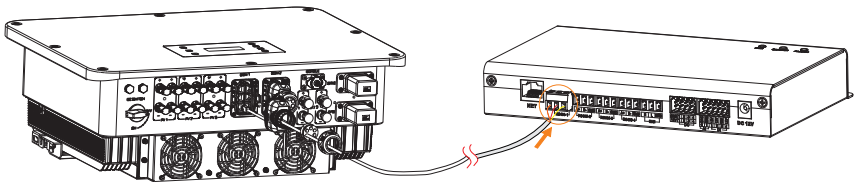
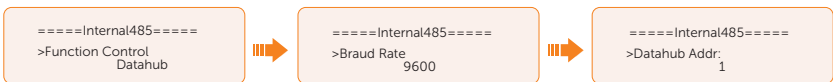

Figure 15-12 Connecting to Datahu

15.4.4 Settings for DataHub

- Select **Menu>Setting>Advance Setting>Internal485**;
- Select the **DataHub** and set the **Baud Rate** and corresponding Address.



NOTICE!

- The baud rate, communication protocol and verification method of the inverters connected to the same RS485 terminal of Datahub must be consistent, and the communication addresses of the inverters must be consecutive and not repeated.

NOTICE!

- For specific wiring and setting procedures of DataHub, see *DataHub 1000 User Manual*.

15.5 Micro-grid Application

15.5.1 Introduction of Micro-grid application

Due to Islanding Effect, on-grid inverter is unable to work during off-grid. This characteristic makes user losing the on-grid inverter PV energy when off-grid. Micro-grid is the function that making hybrid inverter simulate the grid to active on-grid inverter during off-grid by connecting on-grid inverter to hybrid inverter's EPS terminal.

15.5.2 Wiring conenction diagram

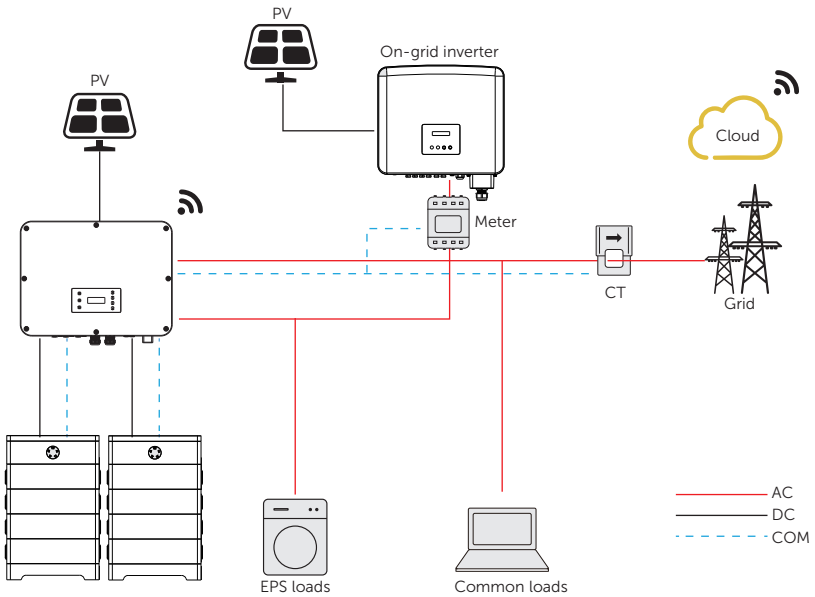

Figure 15-13 Micro-grid wiring connection

15.5.3 Working modes

Grid on

- When PV is sufficient, the hybrid and on-grid inverters power the common and EPS loads together. When there is surplus energy on the on-grid inverter, it will also charge the battery.
- When PV is insufficient, the hybrid, on-grid inverter and grid power all the loads.

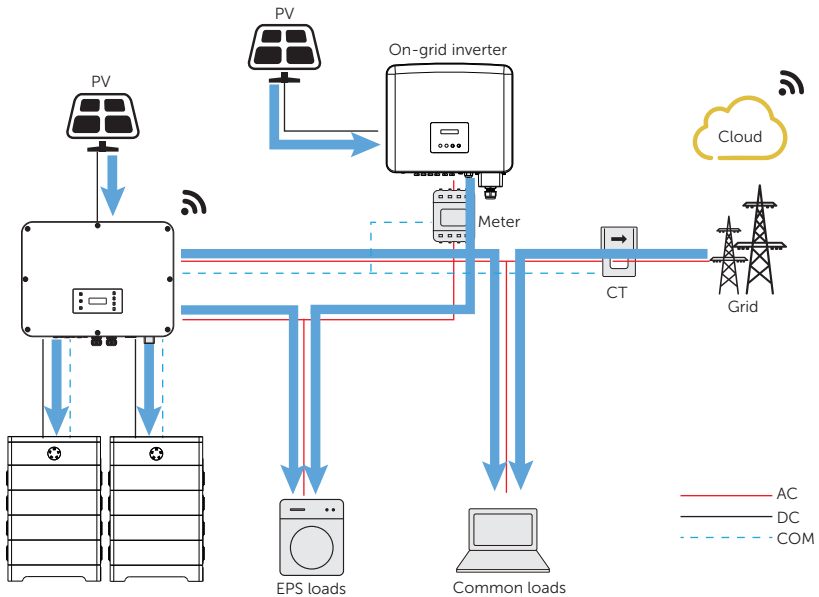

Figure 15-14 Power flowing when grid on and PV sufficient

Grid off

In this case, the hybrid inverter will simulate the grid so as to make the on-grid inverter work. Hybrid and on-grid inverter will power the EPS loads together. If there is surplus energy, it will charge the battery.

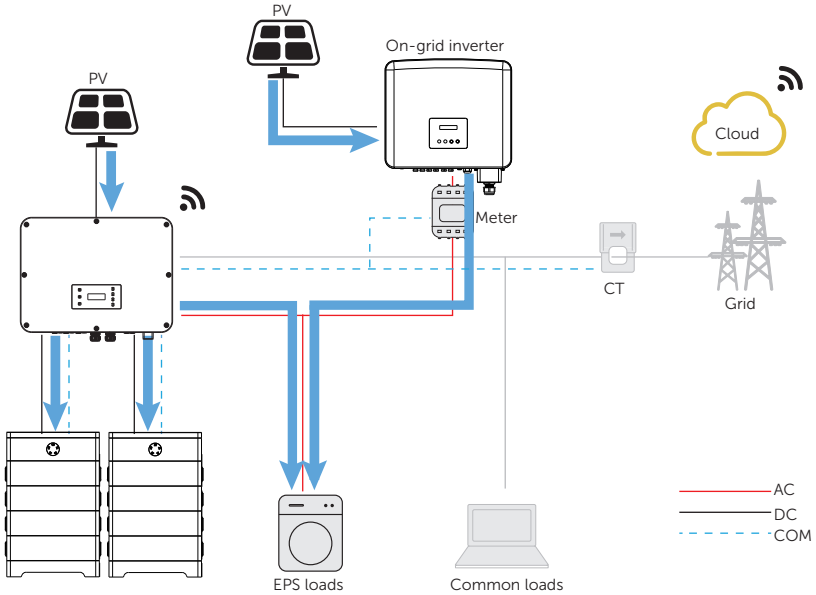

Figure 15-15 Power flowing when grid off

NOTICE!

- In EPS mode, due to limited battery charging power, the hybrid inverter will increase the EPS output frequency to restrict and shut down the on-grid inverter, ensuring the stable operation of the entire system. In this period, the on-grid inverter may report a **Grid frequency Fault** which is a normal phenomenon.

Notice for micro-grid application

- Any brand of on-grid inverter that supports "frequency adaptation".
- On-grid inverter output power ≤ Max hybrid inverter EPS output power.
- On-grid inverter output power ≤ Max battery charging power.

NOTICE!

- Since X3-ULTRA series inverter is unable to control the output power of on-grid inverter in grid connection mode, therefore X3-ULTRA series inverter can not achieve zero export when loads power + battery charging power < on-grid inverter output power.

15.5.4 Cable connection (Hybrid inverter)

Please refer to "8.3 AC Connection" for Grid and EPS connection on X3-ULTRA series inverter.

15.5.5 Cable connection (On-grid inverter)

Please connect the AC cable of on-grid inverter to the EPS terminal of X3-ULTRA series inverter. Please refer to the user manual of specific on-grid inverter.

15.5.6 Cable connection (Meter)

To detect and monitor the power data generated from the on-grid inverter, install a meter on the on-grid inverter side. Otherwise, the relevant power data of on-grid inverter can not be monitored.

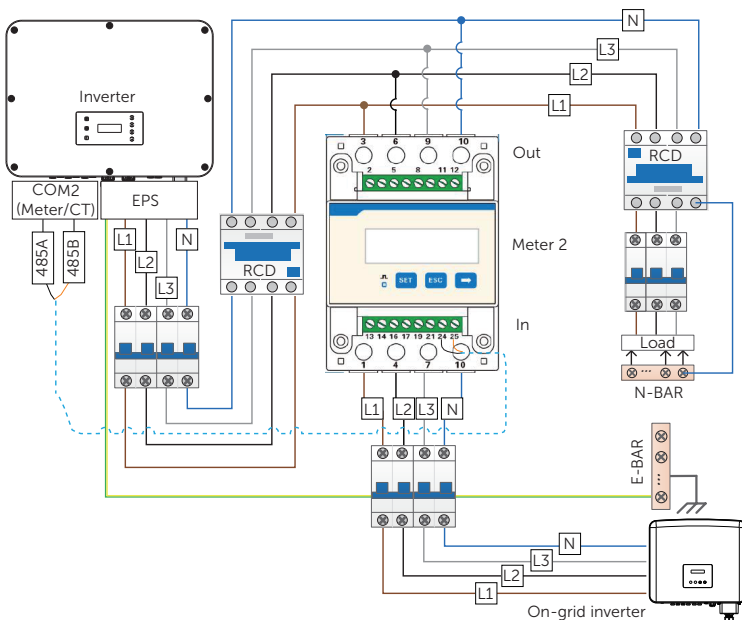

Figure 15-16 Connection diagram of Meter on EPS terminal

NOTICE!

- If a splitter adapter for RJ45 terminal is used, it should be placed in a waterproof enclosure.

- Pin assignment

Table 15-5 Pin assignment for meter and CT

Application	For CT1			For meter		For CT2		
Pin	1	2	3	4	5	6	7	8
Assignment	CT_ R1_ CON	CT_ S1_ CON	CT_ T1_ CON	METER _485A	METER _485B	CT_ T2_ CON	CT_ S2_ CON	CT_ R2_ CON

- Meter/CT connection steps-Please refer to "[8.7.2 Meter/CT Connection](#)" and meter/CT user manual for specific connection steps.

- Setting on the LCD

For meter 1 and meter 2 solution (Meter 1 for grid connection, Meter 2 for EPS)

- a. Select **Menu>Setting>Advance Setting>Meter/CT Setting**.
- b. Set the address and direction of Meter 1: You can check the connection status in **Meter/CT Check**.



- c. Set the the address and direction of Meter 2. You can check the connection status in **Meter/CT Check**.



- d. After connection succeeded, check the feed-in power of Meter 1 in the path of **Menu>System Status>Meter/CT** and check the output power (**Output Today** and **Output Total**) of Meter 2 in the path of **Menu>History Data>E_USERDEF**.

For CT and meter 2 solution (CT for grid connection, Meter 2 for EPS)

- a. Select **Menu>Setting>Advance Setting>Meter/CT Setting**.
- b. Select and enable the CT function, select the CT. You can check the connection status in **Meter/CT Check**.

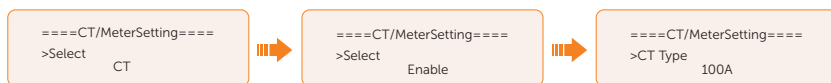

- c. Set the the address and direction of Meter 2. You can check the connection status in **Meter/CT Check**.



- d. After connection succeeded, check the feed-in power of Meter 1 in the path of **Menu>System Status>Meter/CT** and check the output power (**Output Today** and **Output Total**) of Meter 2 in the path of **Menu>History Data>E_USERDEF**.

15.6 Application of Parallel Function

15.6.1 Introduction of parallel application

The series inverters supports parallel operation in both Grid and EPS modes. It can be configured with SolaX X3-EPS Parallel BOX or without one. Without X3-EPS Parallel BOX, it supports up to 3 units in the parallel system, while with X3-EPS Parallel BOX, it supports up to 10 units. Details as follows

15.6.2 Notice for parallel application

- All inverters should be of the same software version.
- For optimal efficiency, it is recommended that all inverters have the same model, and are connected to batteries of the same model and quantity.
- In parallel system, there are three status: **Free**, **Slave** and **Master**.

Table 15-6 Three status

Free	Only if no one inverter is set as a Master , all inverters are in Free mode in the system.
Slave	Once one inverter is set as a Master , all other inverters will enter Slave mode automatically. Slave mode can not be changed from other modes by LCD setting.
Master	When one inverter is set as a Master , this inverter enters Master mode. Master mode can be changed to Free mode.

- Master inverter has an absolute lead in the parallel system to control all slave inverter's energy management and dispatch control. Once master inverter has some error and stop working, all slave inverter will be stop simultaneously. But master inverter is independent of all slave inverter to work and will not be affected by slave inverter's fault.

- Overall system will be running according to master inverter's setting parameters, and most setting parameters of slave inverter will be kept but not be cancelled.
- Once slave inverter exits from the system and be running as an independent unit (the network cable is disconnected simultaneously), its all setting will be re-activated.
- The parallel system is extremely complex and requires a large number of cables to be connected. Therefore, the cables must be connected in the correct wire sequence. Otherwise, any small mistake can lead to system failure.

Parallel connection diagram

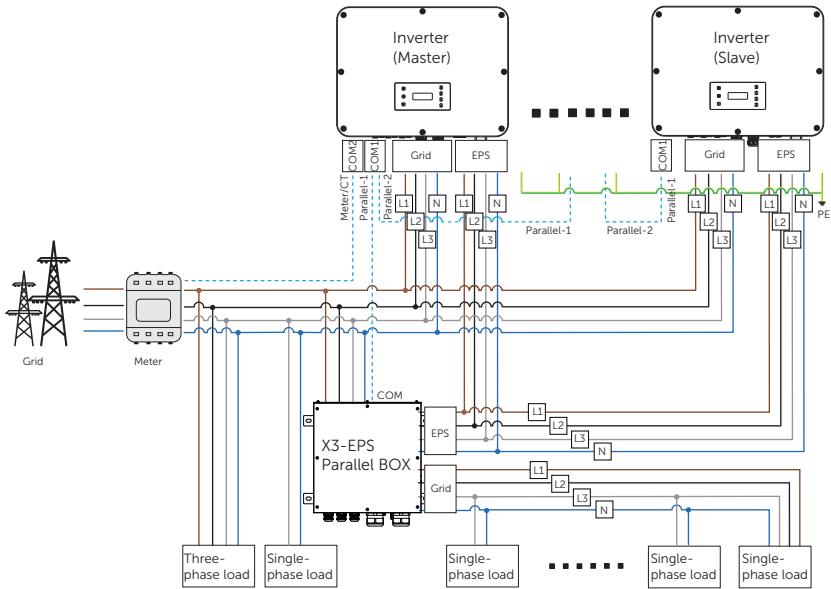

Figure 15-17 System diagram with SolaX X3-EPS Parallel BOX

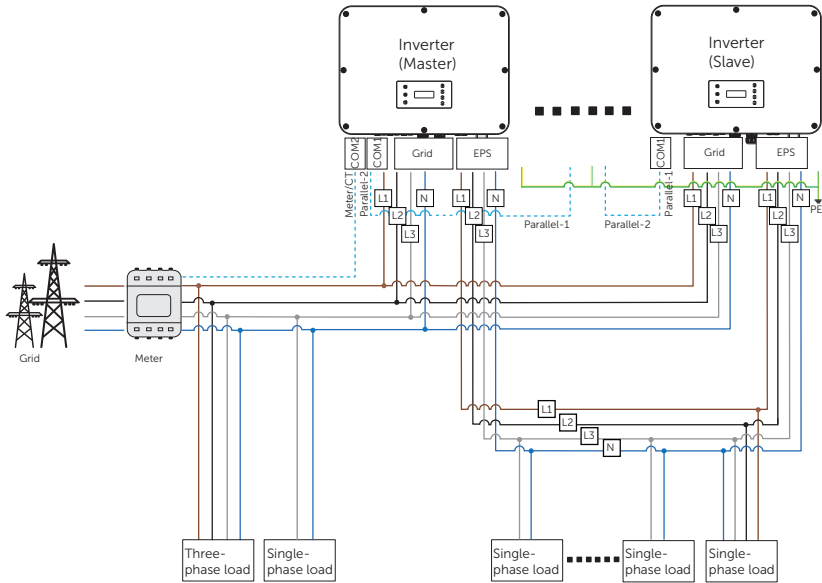

Figure 15-18 System diagram without Solax X3-EPS Parallel BOX

15.6.3 System wiring procedure

Power cable wiring-Grid and EPS terminal

- With X3-EPS Parallel BOX.
 - a. Use five-core copper cable to connect Master-Slave inverter and Master-X3-EPS Parallel BOX .
 - b. Grid terminal of Master, Slave inverter and X3-EPS Parallel BOX: L1 connects to L1, L2 connects to L2, L3 connects to L3 and N connects to N,
 - c. EPS terminal of Master, Slave inverter and X3-EPS Parallel BOX: L1 connects to L1, L2 connects to L2, L3 connects to L3 and N connects to N,
 - d. All PE cable connects to the same E-BAR nearby.

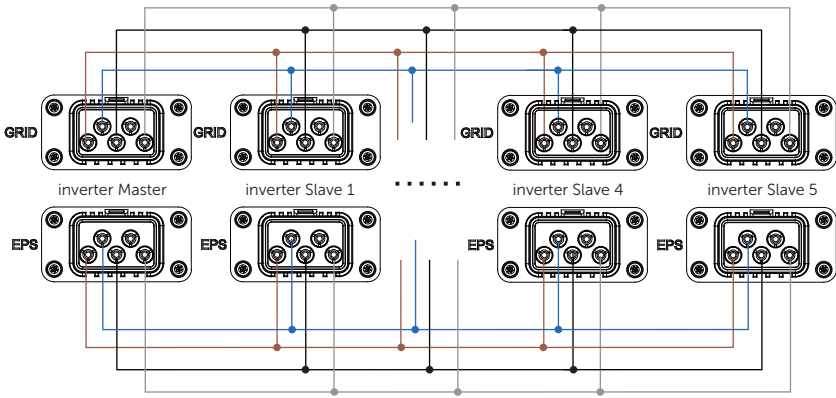

Figure 15-19 Power cable connection with X3-EPS Parallel BOX

- Without X3-EPS Parallel BOX.
 - a. Use five-core copper cable to connect Master-Slave inverter.
 - b. Grid terminal of Master and Slave inverter: L1 connects to L1, L2 connects to L2, L3 connects to L3 and N connects to N,
 - c. EPS terminal of Master and Slave inverter: L1 connects to L1, L2 connects to L2, L3 connects to L3 and N connects to N,
 - d. All PE cable connects to the same E-BAR nearby.

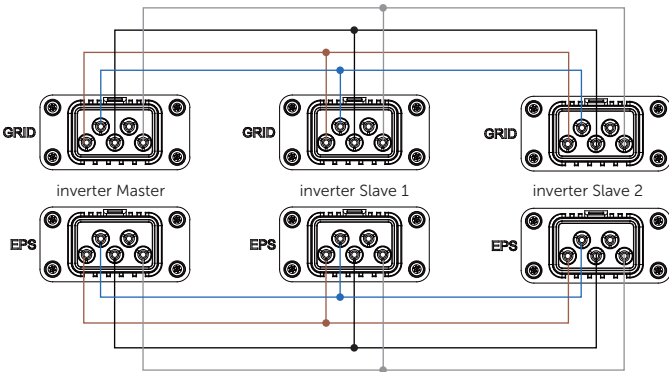

Figure 15-20 Power cable connection without X3-EPS Parallel BOX

Communication cable wiring-COM1 terminal and COM2 terminal

- With X3-EPS Parallel BOX.
 - a. Use standard network cables for Master-Slave inverter connection.
 - b. Master inverter Parallel-1 connects to the COM terminal of X3-EPS Parallel BOX.
 - c. Master inverter Parallel-2 connects to Slave 1 inverter Parallel-1;
 - d. Slave 1 Parallel-2 connects to Slave 2 Parallel-1; other inverters are connected in such way.
 - e. Meter connects to Meter/CT terminal of the Master inverter. Please refer to "8.7.2 Meter/CT Connection".

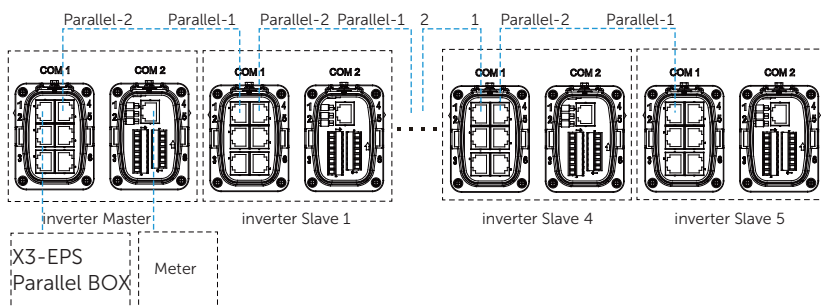

Figure 15-21 Communication connection with X3-EPS Parallel BOX

- Without X3-EPS Parallel BOX.
 - » Use standard network cables for Master-Slave inverter connection.
 - » Master inverter Parallel-2 connects to Slave 1 inverter Parallel-1.
 - » Slave 1 inverter Parallel-2 connects to Slave 2 inverter Parallel-1.
 - » Meter connects to Meter/CT terminal of the master inverter. Please refer to "8.7.2 Meter/CT Connection".

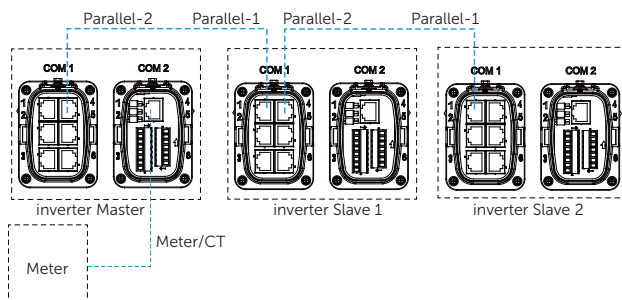

Figure 15-22 Communication connection without X3-EPS Parallel BOX

NOTICE!

- Please refer to X3-EPS Parallel BOX *Installation Guide* for parallel connection on X3-EPS Parallel BOX side.
- Please refer to "8.3 AC Connection" and "8.6.2 Parallel Communication Connection" for the corresponding setup on the inverter.

Meter/CT setting

Setting path: **Menu>Setting>Advance Setting>Meter/CT Setting**. For details, see "[Meter/CT Setting](#)".

Parallel setting

Setting path: **Menu>Setting>Advance Setting>Parallel Setting**.

How to build the parallel connection

- a. Turn on the power of the entire system, find the inverter which needs to be set as Master and connect the meter to Master inverter, enter the setting page of the Master inverter LCD screen, select the **Parallel Setting**, and select **Master**; then enter the **Resistance Switch** and set it to **ON**;



- b. Find the last slave in the parallel system and enter the setting page of the inverter LCD screen and set the **Resistance switch** to **ON**.

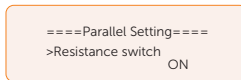

How to remove the parallel connection

- a. Find the inverter which needs to be set as Free. Select the **Parallel Settings** and select **Free** for the inverter

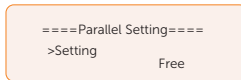

- b. Disconnect all the network cables on the Parallel-1 and Parallel-2 terminal.

NOTICE!

- If a slave inverter is set to **Free** mode but not disconnect the network cable, this inverter will return to **Slave** mode automatically.
- If a slave inverter is disconnected with other inverter but not be set to **Free** mode, this inverter will stop working and report a **ParallelFault**..

External ATS setting

Setting path: **Menu>Setting>Advance Setting>External ATS**.

When the X3-EPS Parallel BOX is connected in the parallel system, enable the function.

```
====External ATS====
Function Control
> Enable <
```

NOTICE!

- If the output power does not reach the expected level, you can check whether the output power is set reasonably by following the path: "**Menu> Setting > Advance Setting > Export Control**".

Parallel display

Displaying path: **Menu>Parallel Status**

NOTICE!

- Once inverter enters parallel system, the **Today** yield will be replaced by **Parallel**.

In **Parallel Status** interface, the whole system power and individual slave inverter power can be obtained in **Parallel Status** interface of master inverter. The number displayed in the **Parallel Status** interface refers to the total number of online inverters, for example two inverters in parallel in the below figure.

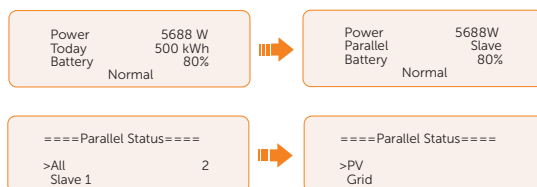

Contact Information



UNITED KINGDOM

- Unit C-D Riversdale House, Riversdale Road, Atherstone, CV9 1FA
- +44 (0) 2476 586 998
- service.uk@solaxpower.com



TURKEY

- Fevzi Çakmak mah. aslım cd. no 88 A Karatay / Konya / Türkiye
- service.tr@solaxpower.com



USA

- 3780 Kilroy Airport Way, Suite 200, Long Beach, CA, US 90806
- +1 (408) 690 9464
- info@solaxpower.com



POLAND

- WARSAW AL. JANA P. II 27. POST
- +48 662 430 292
- service.pl@solaxpower.com



ITALY

- +39 011 19800998
- support@solaxpower.it



PAKISTAN

- service.pk@solaxpower.com



AUSTRALIA

- 21 Nicholas Dr, Dandenong South VIC 3175
- +61 1300 476 529
- service@solaxpower.com



GERMANY

- Am Tullnaupark 8, 90402 Nürnberg, Germany
- +49 (0) 6142 4091 664
- service.eu@solaxpower.com
- service.dach@solaxpower.com



NETHERLANDS

- Twekkeler-Es 15 7547 ST Enschede
- +31 (0) 8527 37932
- service.eu@solaxpower.com
- service.bnl@solaxpower.com



SPAIN

- +34 9373 79607
- tecnico@solaxpower.com



BRAZIL

- +55 (34) 9667 0319
- info@solaxpower.com



SOUTH AFRICA

- service.za@solaxpower.com



SolaX Power Network Technology (Zhejiang) Co., Ltd.

Add.: No. 278, Shizhu Road, Chengnan Sub district, Tonglu County,
Hangzhou, Zhejiang, China

E-mail: info@solaxpower.com

www.solaxpower.com

